

Thule System Kit 193

CITROËN ZX 5-dr, 91-

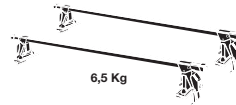

x4

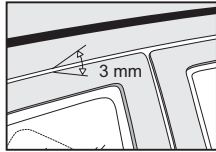

NOTE: For the load carrier to be fitted, the distance between the door and the roof of the vehicle must be at least 3 mm (see fig.). Where this is not the case, please contact your nearest Citroën garage and have them adjust the door.

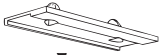

x4

01

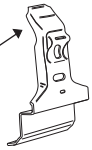

x4

194

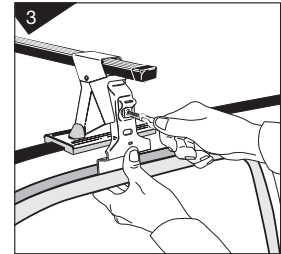
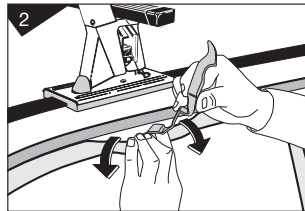
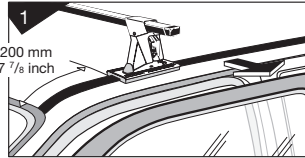
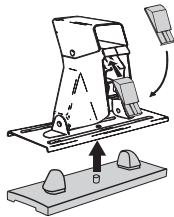

Front

Rear

962 mm / 37 7/8 inch

945 mm / 37 1/4 inch

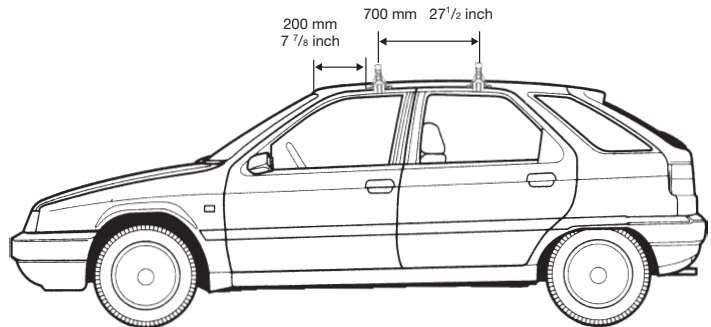

CITROËN ZX 3-dr, 93-

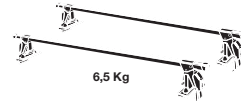

x4

Fit the front load carrier using the brackets Art No 194, as shown in the instructions for the five-door model.

NOTE: Distance between door and roof of the vehicle must be at least 3 mm.

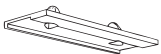

x4

01

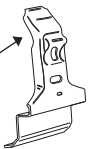

x2

194

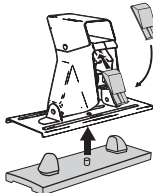

x2

181

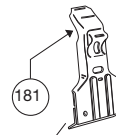
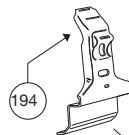

260 mm
10 1/4 inch

700 mm
27 1/2 inch

Front

Rear

956 mm / 37 3/4 inch

945 mm / 37 1/4 inch

