

# Kit 1525

NISSAN Pixo, 5-dr Hatchback, 09–  
SUZUKI Alto, 5-dr Hatchback, 09–

480R  
754

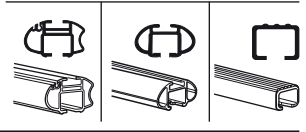
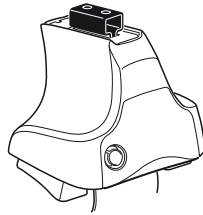

480

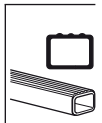
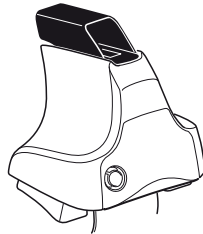

750

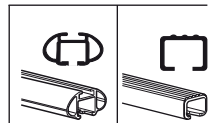
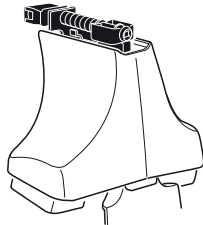



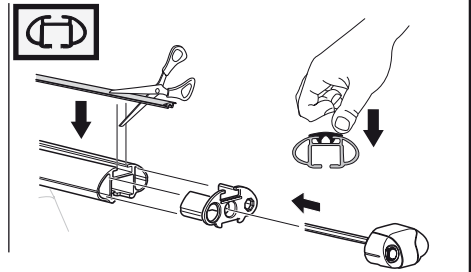
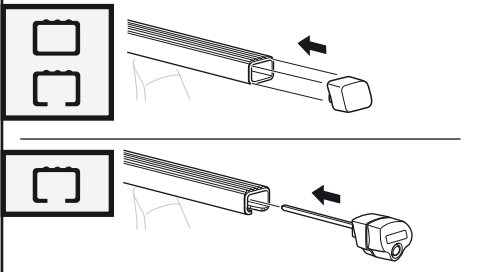
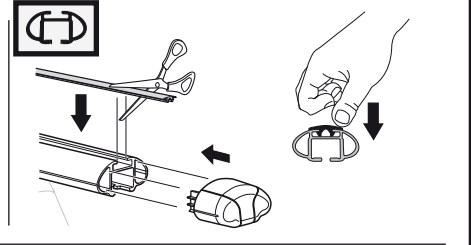
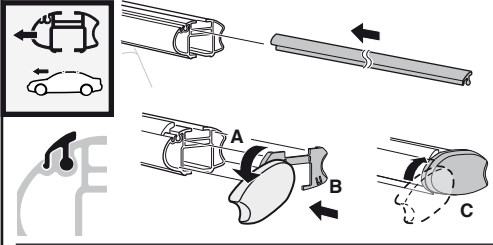
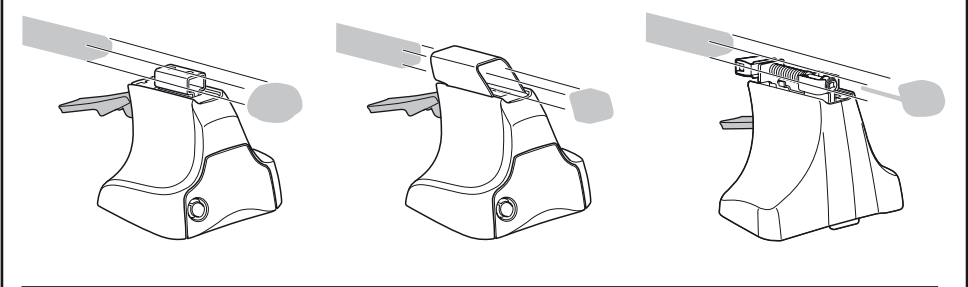
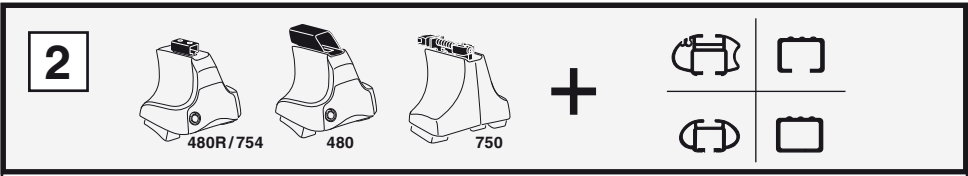
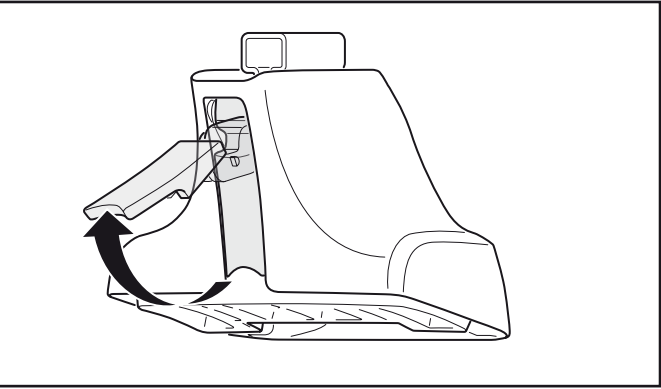
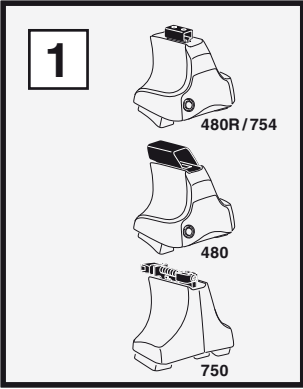

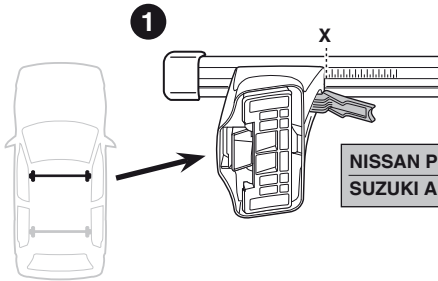
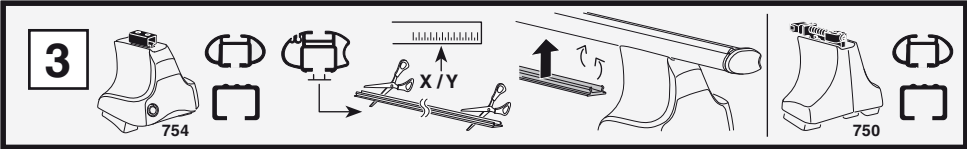

	X
<b>NISSAN Pixo</b> , 5-dr Hatchback, 09–	32
<b>SUZUKI Alto</b> , 5-dr Hatchback, 09–	32

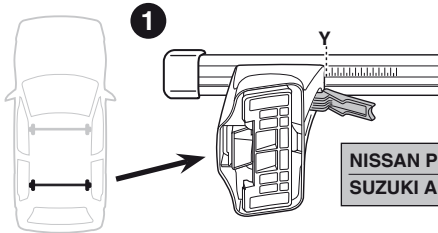

	Y
<b>NISSAN Pixo</b> , 5-dr Hatchback, 09–	28,5
<b>SUZUKI Alto</b> , 5-dr Hatchback, 09–	28,5

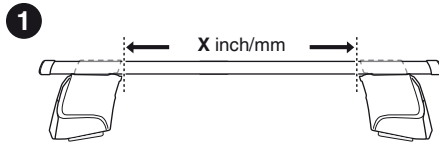
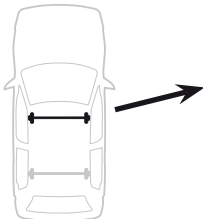
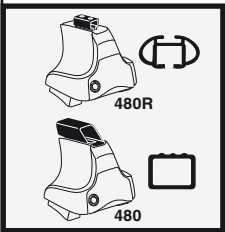

	X inch	X mm
<b>NISSAN Pixo</b> , 5-dr Hatchback, 09–	38 1/4"	971 mm
<b>SUZUKI Alto</b> , 5-dr Hatchback, 09–	38 1/4"	971 mm

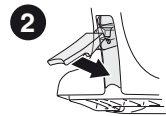
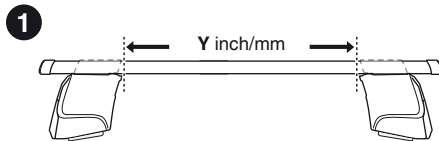
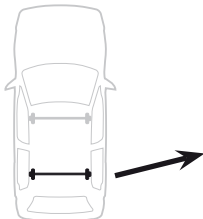

	Y inch	Y mm
<b>NISSAN Pixo</b> , 5-dr Hatchback, 09–	36 7/8"	936 mm
<b>SUZUKI Alto</b> , 5-dr Hatchback, 09–	36 7/8"	936 mm

# 4

NISSAN Pixo, 5-dr Hatchback, 09–  
SUZUKI Alto, 5-dr Hatchback, 09–

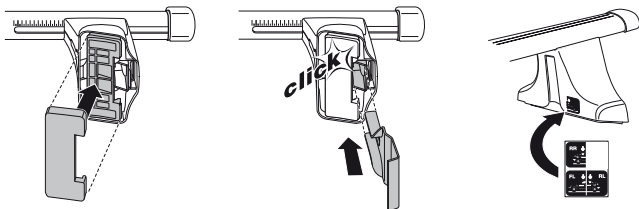
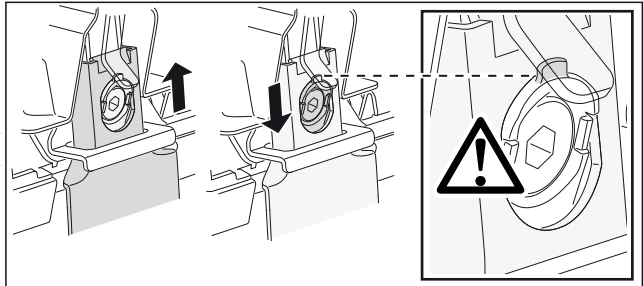
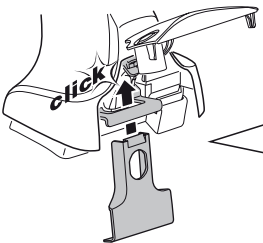
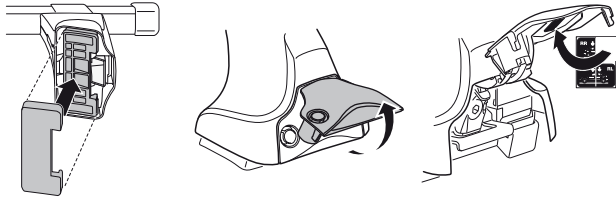
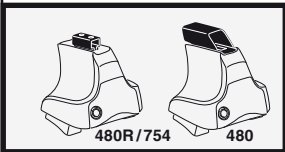
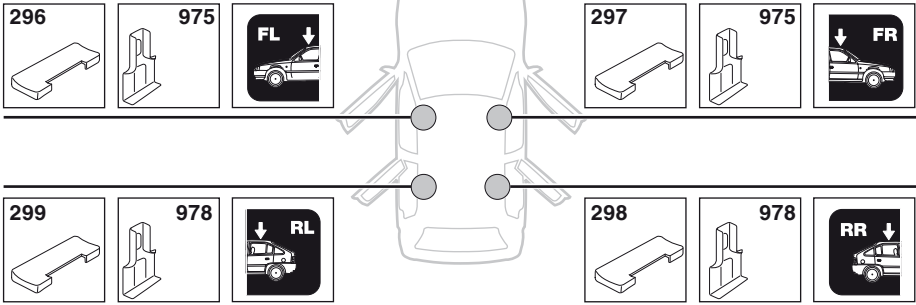

5

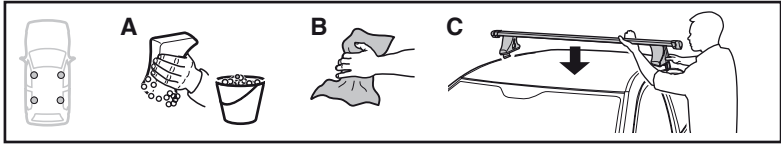

	X mm	Y mm	X inch	Y inch
NISSAN Pixo, 5-dr Hatchback, 09-	255 mm	700 mm	10"	27 1/2"
RENAULT Laguna II, 5-dr Estate, 03/2002-04, 05-	255 mm	700 mm	10"	27 1/2"

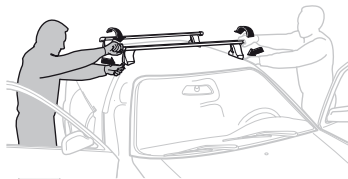
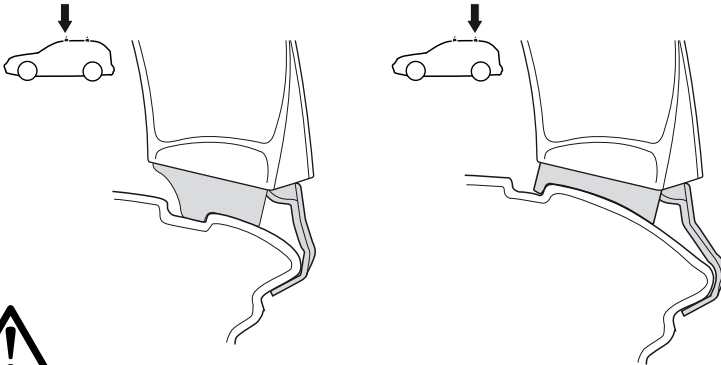
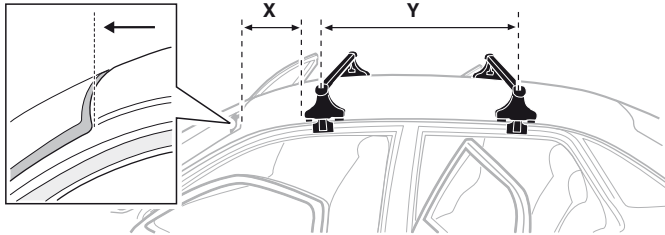

**GB/US** Tighten alternately

**D** Die Schrauben abwechselnd anziehen

**F** Serrer alternativement chaque côté

**NL** Afwisselend aan de linker- en de rechterkant aandraaien

**I** Alternare il serraggio delle viti

**E** Apretar alternativamente

**PT** Aperte alternadamente

**S** Dra åt växelvis

**FIN** Kierrä vuorotellen

**EST** Pinguldage vaheldumisi

**LAT** Pievelciēt pamīšus

**LIT** Užsukinėkite pakaitomis

**PL** Śruby dokręcaj naprzemiennie

**RU** Затягивайте попеременно

**CZ** Pokręťta bagażníka dokręcaj dokręcaj naprzemiennie.

**SK** Doťahujte striedavo

**SLO** Privijajte izmenično.

**HR** Naizmjenično zategnite

**HU** Egymástól függetlenül szorítandó

**GR** Σφίγγετε εναλλάξ

**TR** Dönüşümlü sıkın

**中文** 交替拧紧

**한국어** 번갈아 가며 조이십시오.

**日本語** 交互に締め付けてください。

**ไทย** ชั้้นโน้บแบบสลับ

6



480R/754



480

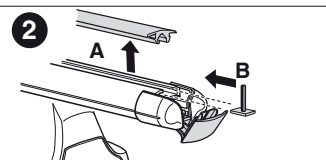
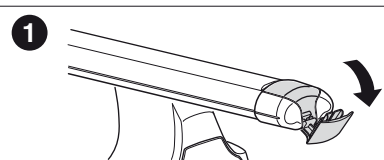
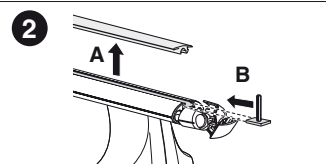
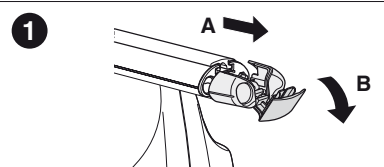
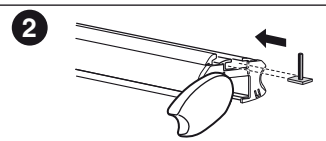
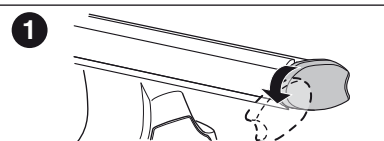
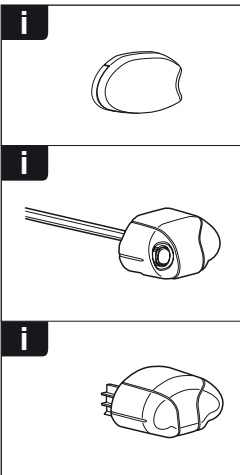
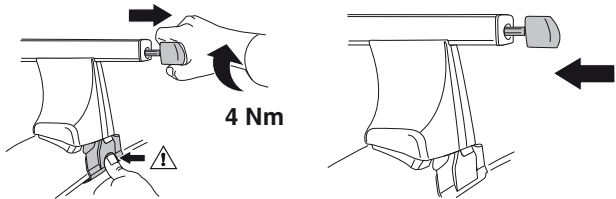
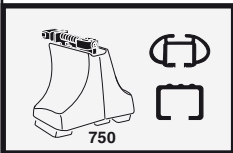
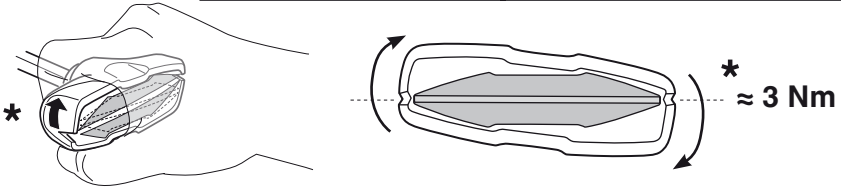
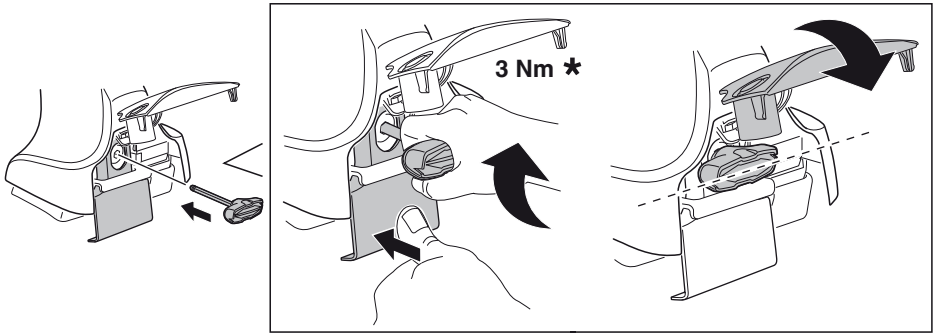

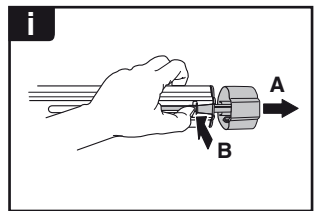
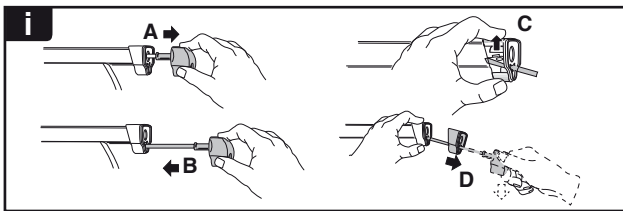
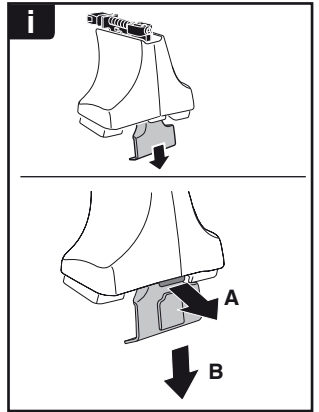
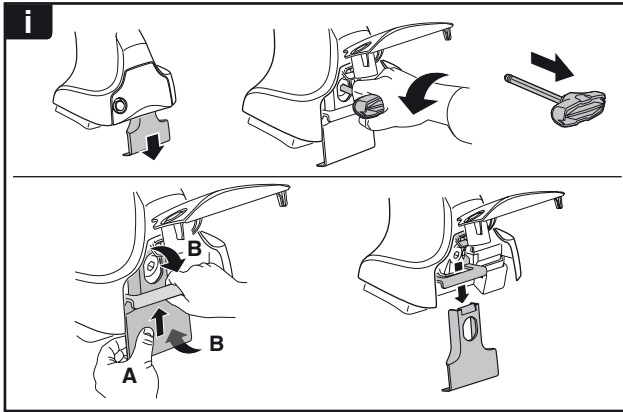
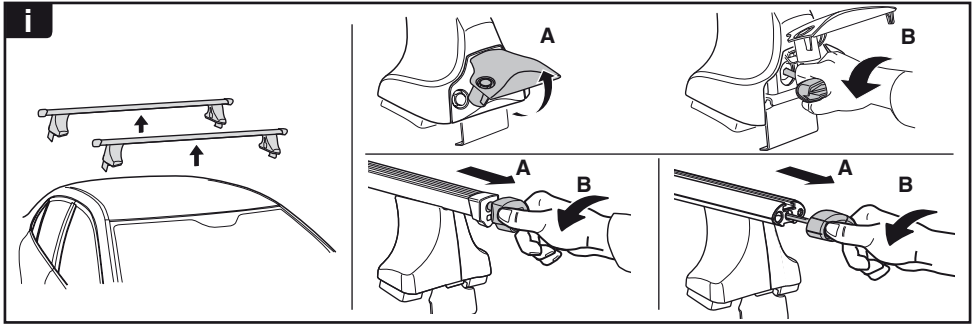

**THULE**  
SWEDEN  
**ONE  
KEY  
SYSTEM**

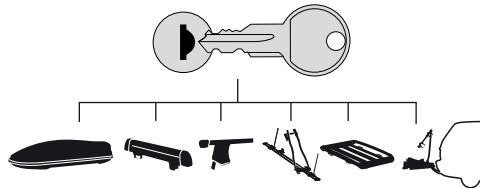

		544	(x4)
		596	(x6)
		588	(x8)
NA		510	(x10)
EUR		452	(x12)
ASIA			

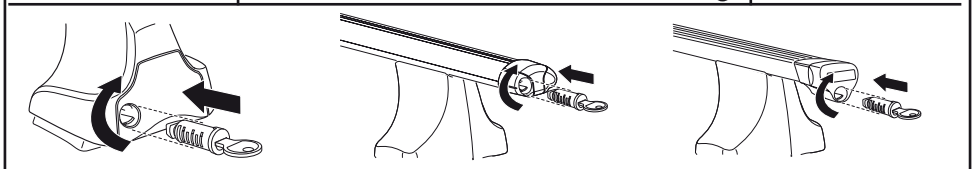

WW ▶ Thule Sweden AB, Box 69, 330 33 Hillerstorp, SWEDEN  
NA ▶ Thule Inc., 42 Silvermine Road, Seymour, Connecticut 06483, USA

info@thule.com  
customer.service@thule.com

www.thule.com