

Kit 1510

HONDA Pilot, 5-dr SUV, 06-09*

HONDA Ridgeline, 4-dr Pickup, 06-*

*w/o factory rack

480R
754

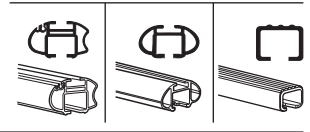
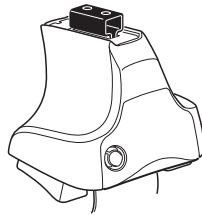

480

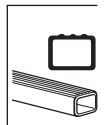
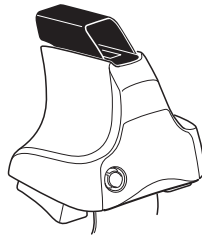

750

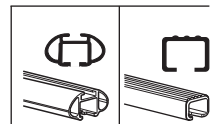
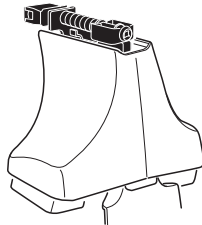

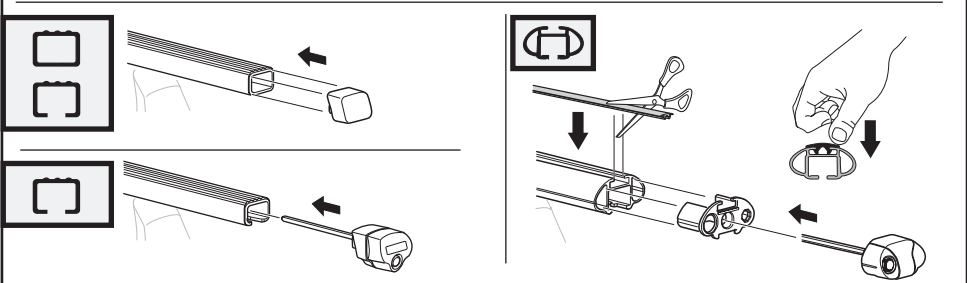
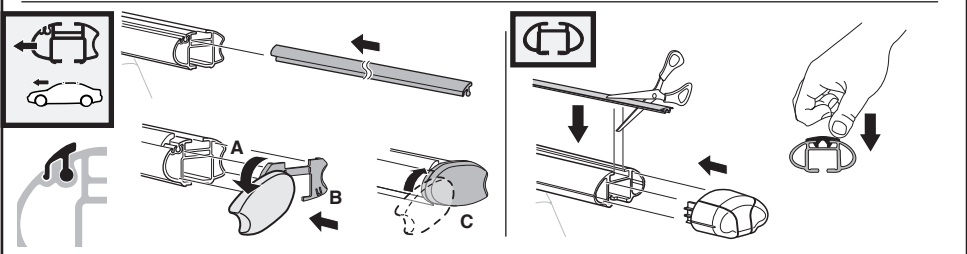
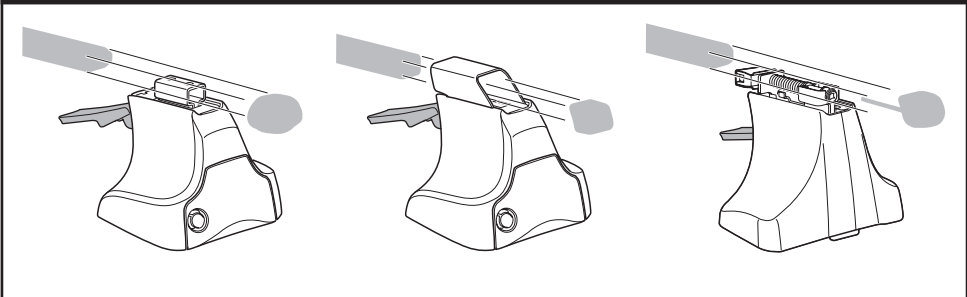
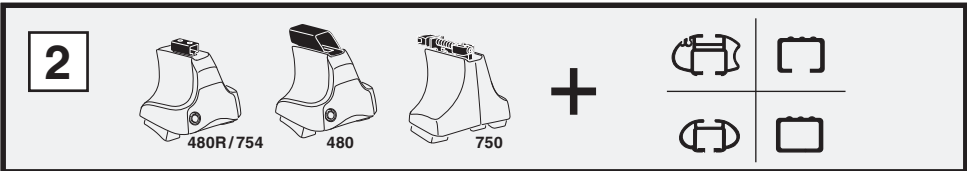
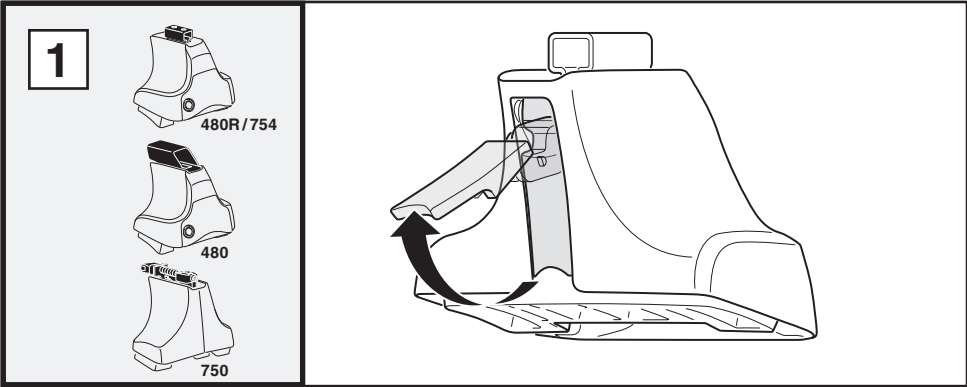

3



754

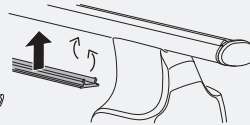
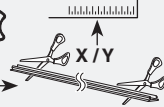

750



1

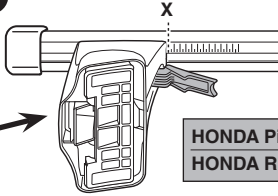
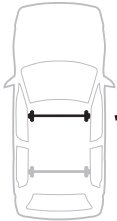

2

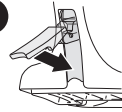

HONDA Pilot, 5-dr SUV, 06-09

HONDA Ridgeback, 4-dr Pickup, 06-

X

56

56

1

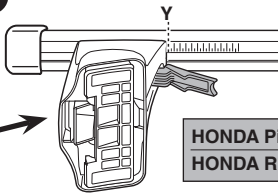
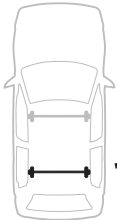

2

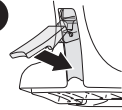

HONDA Pilot, 5-dr SUV, 06-09

HONDA Ridgeback, 4-dr Pickup, 06-

Y

53,5

53,5



480R



480

1

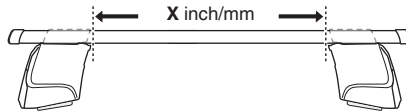

2

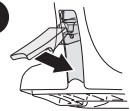

X inch

X mm

HONDA Pilot, 5-dr SUV, 06-09

HONDA Ridgeback, 4-dr Pickup, 06-

47 1/2"

1211 mm

47 1/2"

1211 mm

1

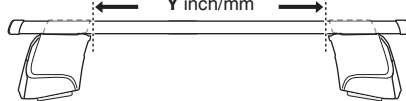

2

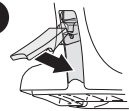

Y inch

Y mm

HONDA Pilot, 5-dr SUV, 06-09

HONDA Ridgeback, 4-dr Pickup, 06-

46 3/4"

1186 mm

46 3/4"

1186 mm

4

HONDA Pilot, 5-dr SUV, 06-09
HONDA Ridgeback, 4-dr Pickup, 06-

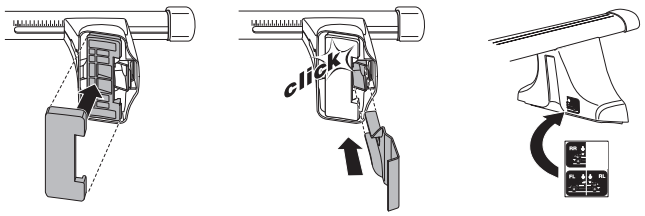
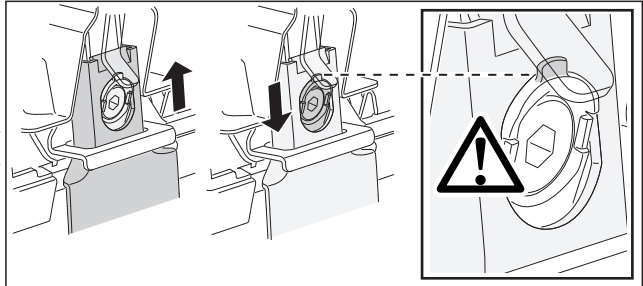
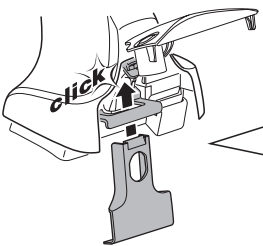
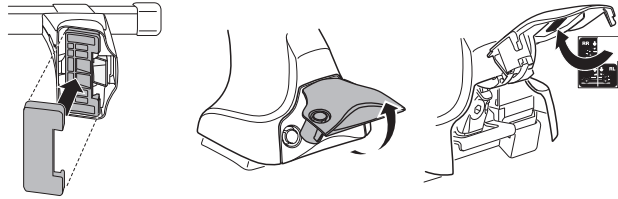
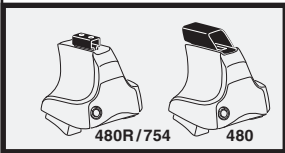
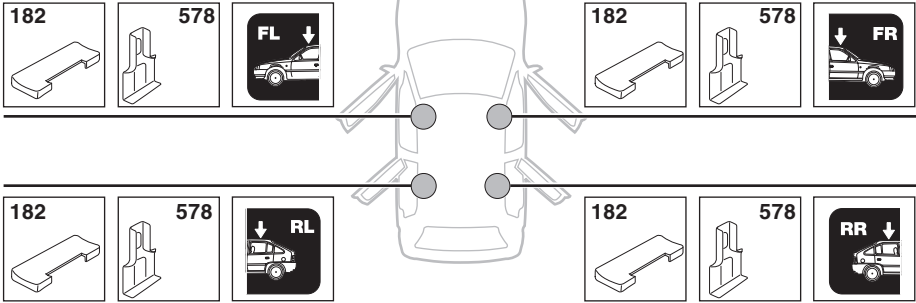

5

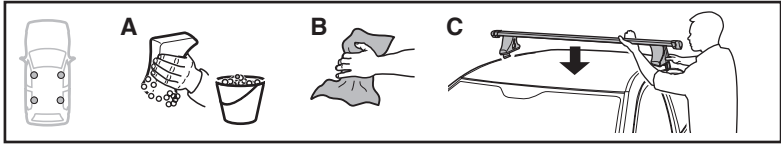

	X mm	Y mm	X inch	Y inch
HONDA Pilot, 5-dr SUV, 06-09	260 mm	750 mm	10 1/4"	29 1/2"
HONDA Ridgeback, 4-dr Pickup, 06-	260 mm	750 mm	10 1/4"	29 1/2"

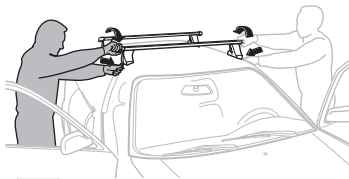
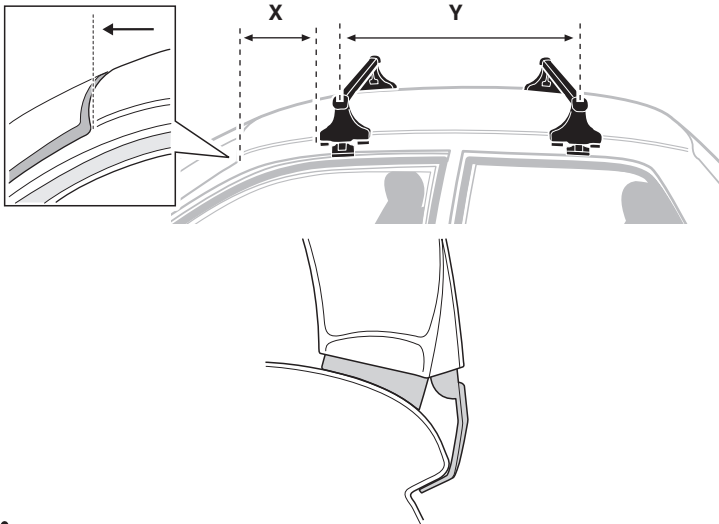

GB/US Tighten alternately

D Die Schrauben abwechselnd anziehen

F Serrer alternativement chaque côté

NL Afwisselend aan de linker- en de rechterkant aandraaien

I Alternare il serraggio delle viti

E Serrare alternativamente

PT Aperte alternadamente

S Dra åt växelsvis

FIN Kierrä vuorotellen

EST Pinguldage vaheldumisi

LAT Pielvelciet pamišus

LIT Užsukinėkite pakaitomis

PL Śruby dokręcaj naprzemiennie

RU Затягивайте попеременно

CZ Pokręťta bagażníka dokręcaj dokręcaj naprzemiennie.

SK Doťahujte striedavo

SLO Privijajte izmenično.

HR Naizmjenično zategnite

HU Egymástól függetlenül szorítandó

GR Σφίγγετε εναλλάξ

TR Dönüşümlü sıkın

中文 交替拧紧

한국어 번갈아 가며 조이십시오.

日本語 交互に締め付けてください。

ไทย ชั้้นในแบบสลับ

6



480R/754



480

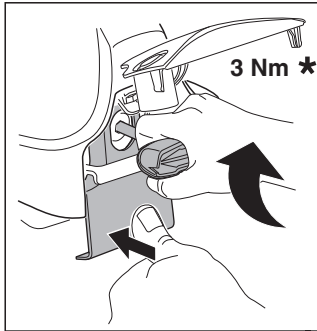
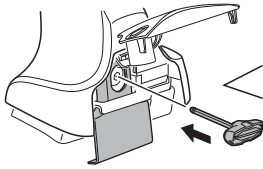

3 Nm *

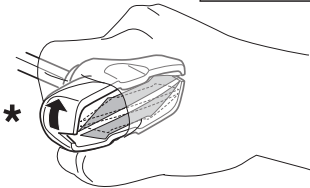
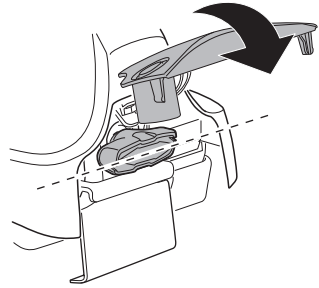

*

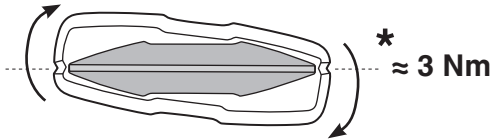

* ≈ 3 Nm



750

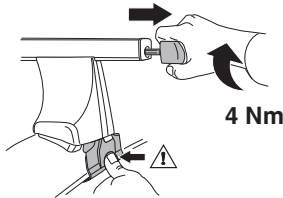

4 Nm

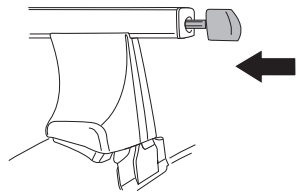

i



1



2

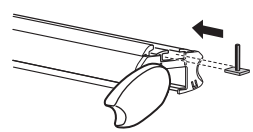

i

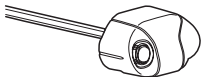

1

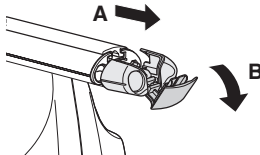

2

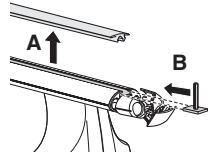

i



1

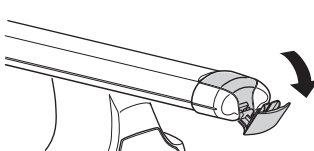

2

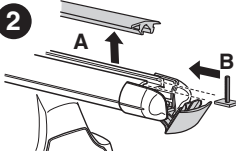

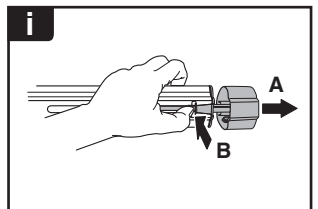
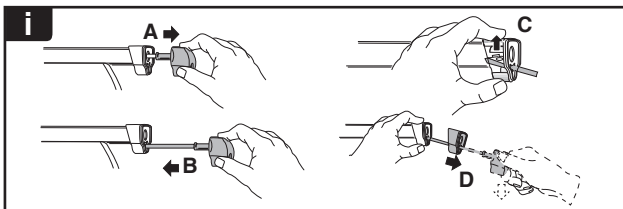
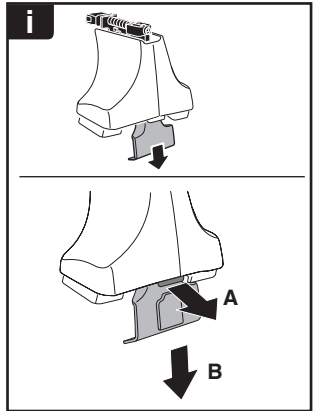
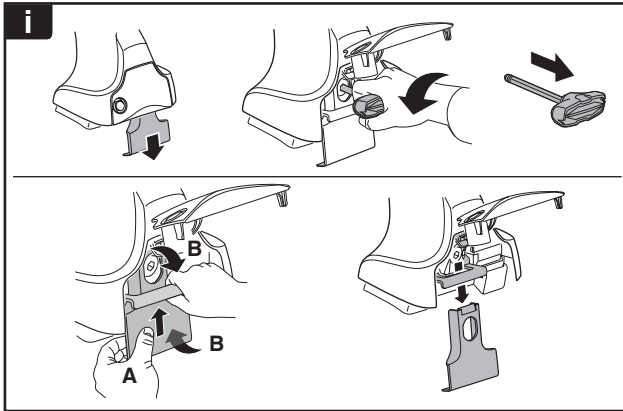
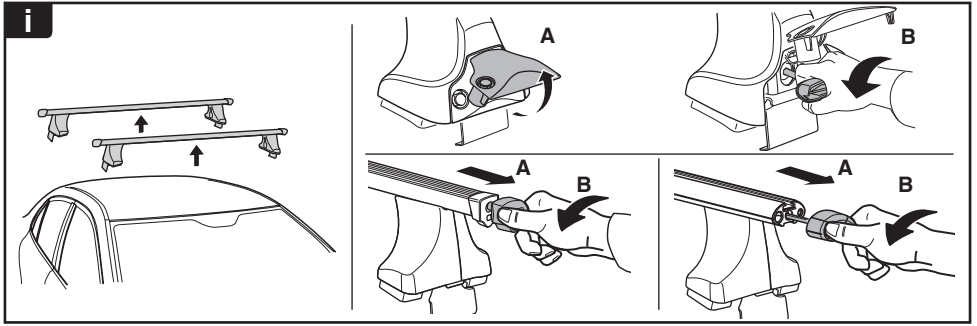

THULE
SWEDEN
**ONE
KEY
SYSTEM**

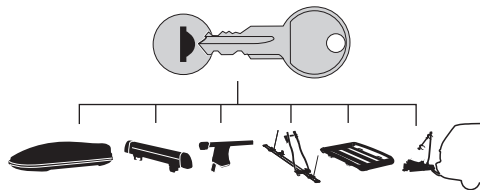

- 544 (x4)
- 596 (x6)
- 588 (x8)
- NA 510 (x10)
- EUR 452 (x12)
- ASIA

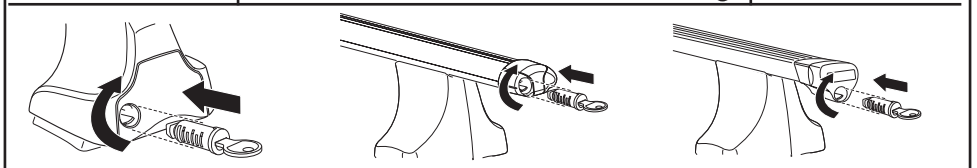

WW ▶ Thule Sweden AB, Box 69, 330 33 Hillerstorp, SWEDEN
NA ▶ Thule Inc., 42 Silvermine Road, Seymour, Connecticut 06483, USA

info@thule.com
customer.service@thule.com

www.thule.com