

# Kit 1468

TOYOTA Ist (Mk.II), 5-dr Hatchback, 07–  
TOYOTA Urban Cruiser, 5-dr Hatchback, 09–  
SCION xD, 5-dr Hatchback, 08–

480R  
754

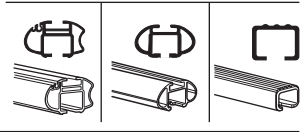
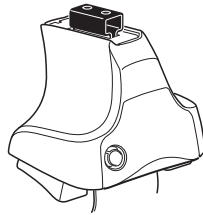

480

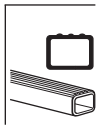
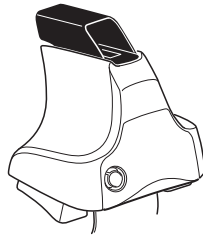

750

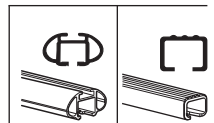
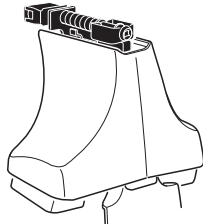

**THULE**<sup>®</sup>  
SWEDEN

ISO 11154-E



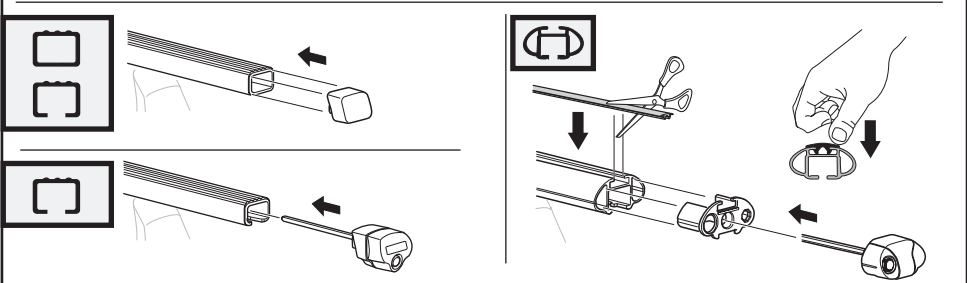
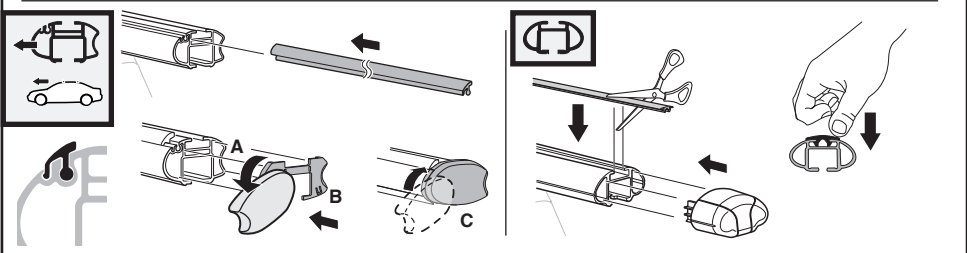
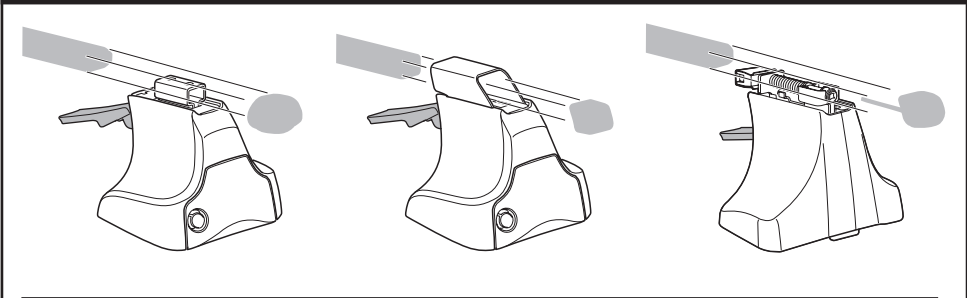
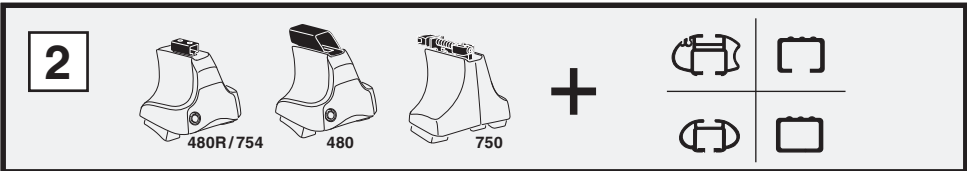
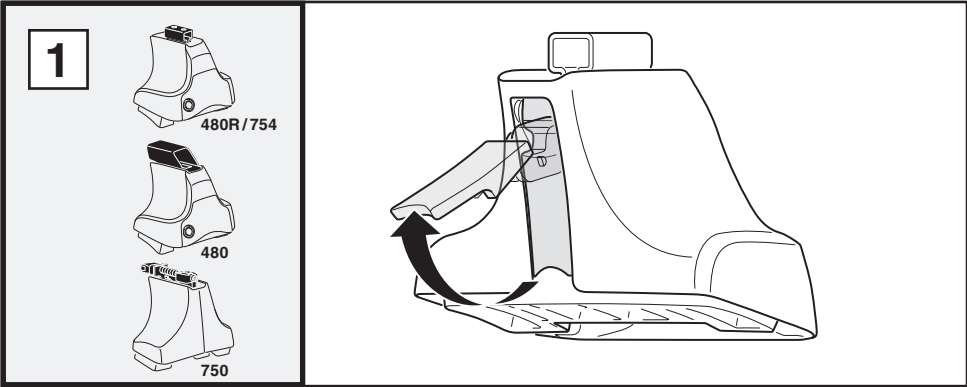

3



754

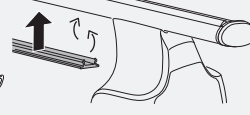
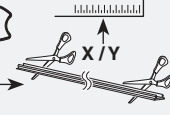

750



1

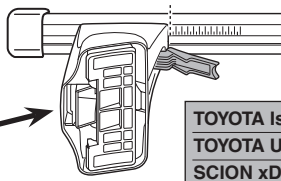
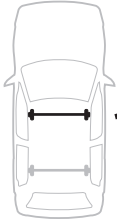

2

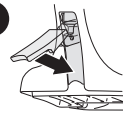

X

TOYOTA Ist (Mk.II), 5-dr Hatchback, 07-	31,5
TOYOTA Urban Cruiser, 5-dr Hatchback, 09-	31,5
SCION xD, 5-dr Hatchback, 08-	31,5

1

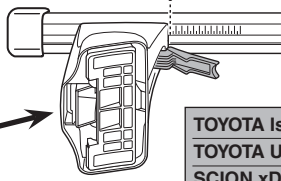

2



Y

TOYOTA Ist (Mk.II), 5-dr Hatchback, 07-	28
TOYOTA Urban Cruiser, 5-dr Hatchback, 09-	28
SCION xD, 5-dr Hatchback, 08-	28



480R



480

1

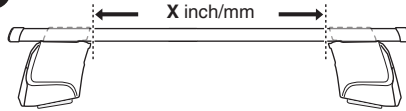

2

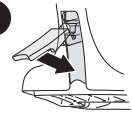

X inch X mm

TOYOTA Ist (Mk.II), 5-dr Hatchback, 07-	38"	966 mm
TOYOTA Urban Cruiser, 5-dr Hatchback, 09-	38"	966 mm
SCION xD, 5-dr Hatchback, 08-	38"	966 mm

1

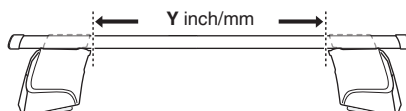

2

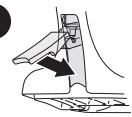

Y inch Y mm

TOYOTA Ist (Mk.II), 5-dr Hatchback, 07-	36 <sup>5</sup> / <sub>8</sub> "	931 mm
TOYOTA Urban Cruiser, 5-dr Hatchback, 09-	36 <sup>5</sup> / <sub>8</sub> "	931 mm
SCION xD, 5-dr Hatchback, 08-	36 <sup>5</sup> / <sub>8</sub> "	931 mm

4

TOYOTA Ist (Mk.II), 5-dr Hatchback, 07–  
TOYOTA Urban Cruiser, 5-dr Hatchback, 09–  
SCION xD, 5-dr Hatchback, 08–

204



944



206



944

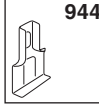

172



943



172



943

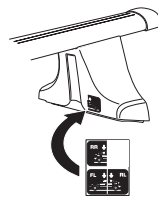
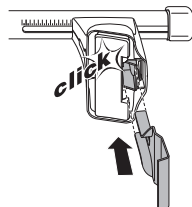
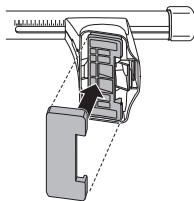
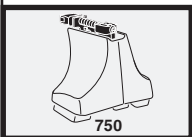
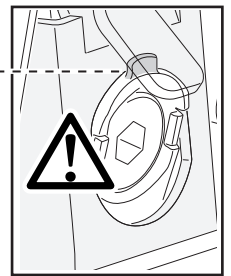
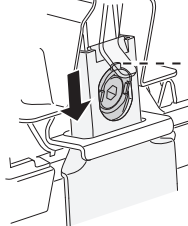
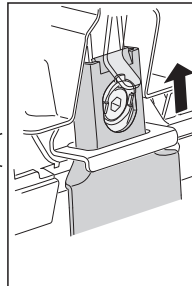
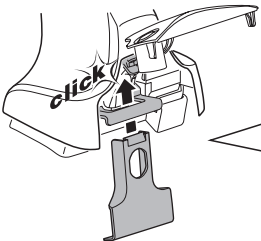
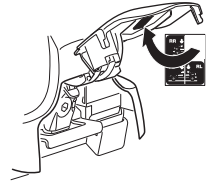
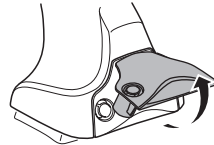
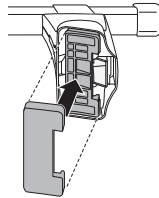
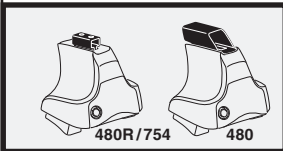
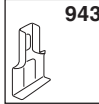

5

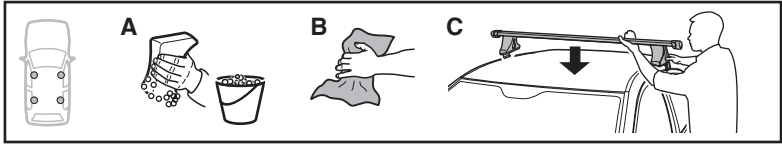

	X mm	Y mm	X inch	Y inch
TOYOTA Ist (Mk.II), 5-dr Hatchback, 07–	170 mm	715 mm	6 <sup>3</sup> / <sub>4</sub> ”	28 <sup>1</sup> / <sub>8</sub> ”
TOYOTA Urban Cruiser, 5-dr Hatchback, 09–	170 mm	715 mm	6 <sup>3</sup> / <sub>4</sub> ”	28 <sup>1</sup> / <sub>8</sub> ”
SCION xD, 5-dr Hatchback, 08–	170 mm	715 mm	6 <sup>3</sup> / <sub>4</sub> ”	28 <sup>1</sup> / <sub>8</sub> ”

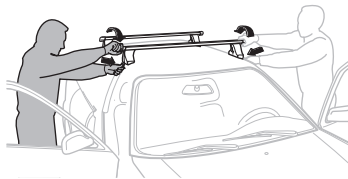
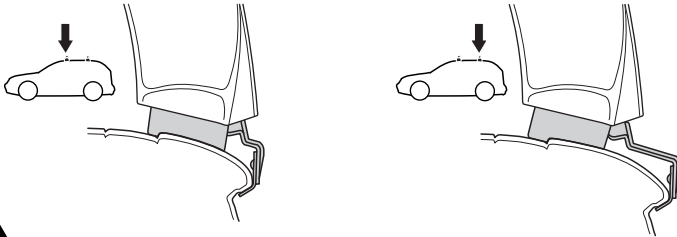
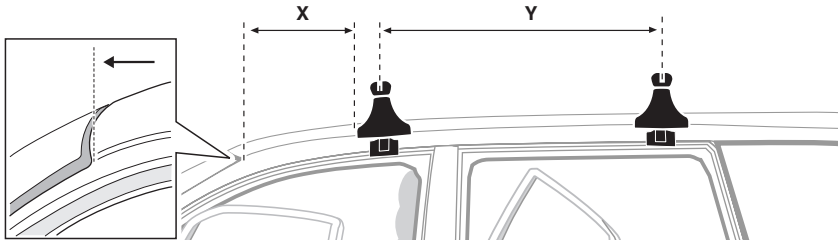

**GB/US** Tighten alternately

**D** Die Schrauben abwechselnd anziehen

**F** Serrer alternativement chaque côté

**NL** Afwisselend aan de linker- en de rechterkant aandraaien

**I** Alternare il serraggio delle viti

**E** Serrare alternativamente

**PT** Aperte alternadamente

**S** Dra åt växelvis

**FIN** Kierrä vuorotellen

**EST** Pinguldage vaheldumisi

**LAT** Pieveļciet pamišus

**LIT** Užsukinėkite pakaitomis

**PL** Śruby dokręcaj naprzemiennie

**RU** Затягивайте попеременно

**CZ** Pokręťta bagažníka dokręcaj dokręcaj naprzemiennie.

**SK** Doťahujte striedavo

**SLO** Privijajte izmenično.

**HR** Naizmjenično zategnite

**HU** Egymástól függetlenül szorítandó

**GR** Σφιγγετε εναλλάξ

**TR** Dönüşümlü sıkın

**中文** 交替拧紧

**한국어** 번갈아 가며 조이십시오.

**日本語** 交互に締め付けてください。

**ไทย** ชั้นโนแบบสลับ

6



480R/754



480

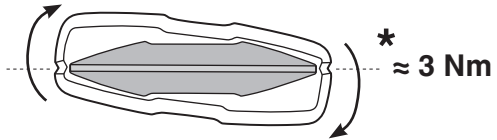
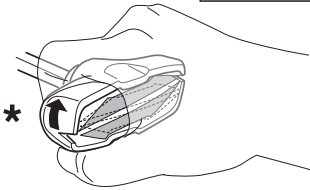
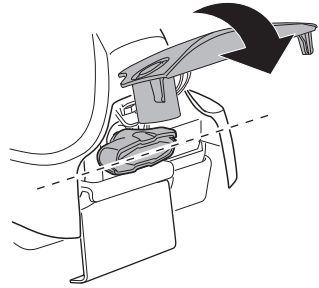
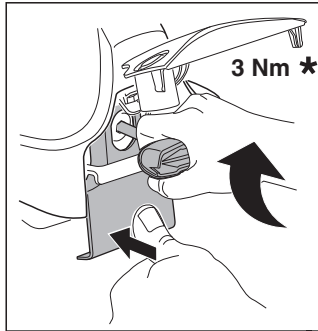
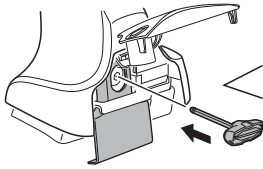

750

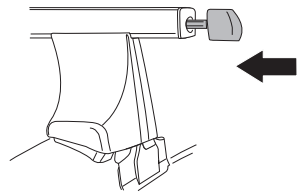
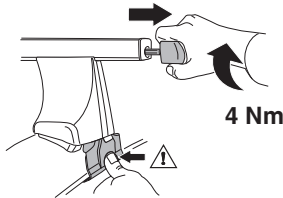

i



1



2

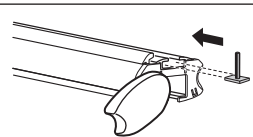

i

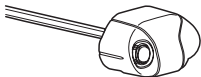

1

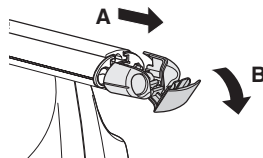

2

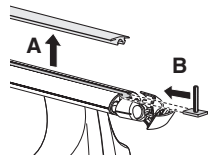

i



1

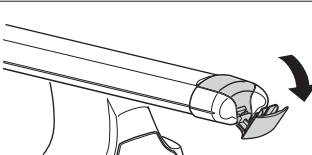



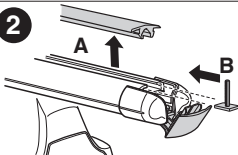

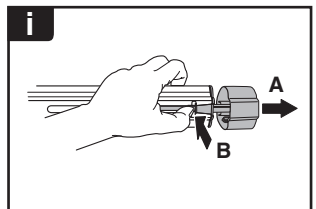
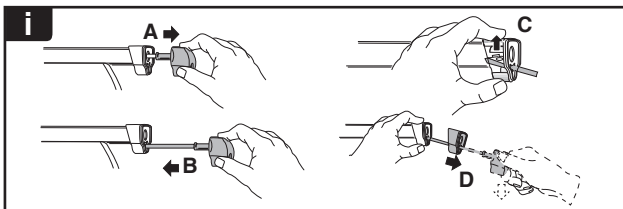
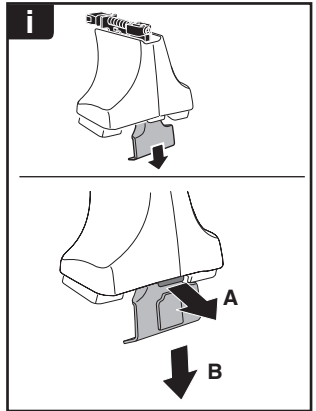
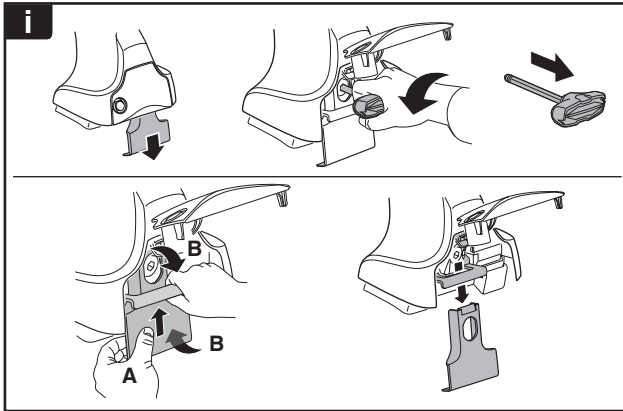
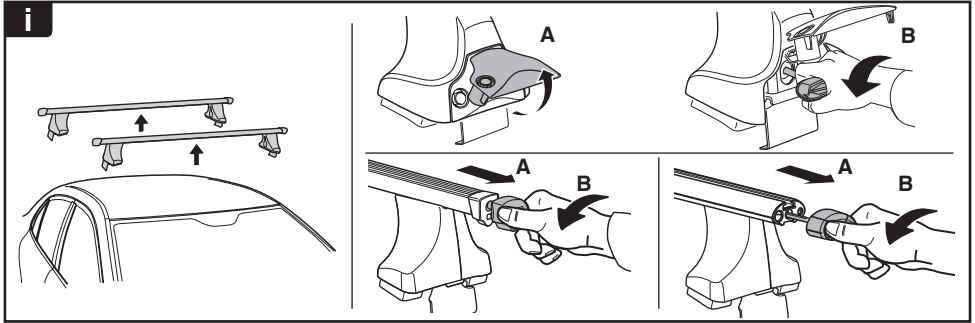

2

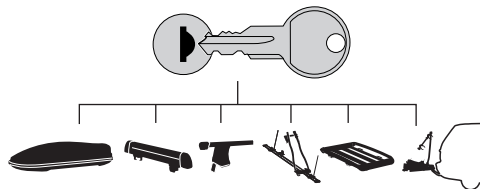



**THULE**  
SWEDEN  
**ONE  
KEY  
SYSTEM**



-  **544** (x4)
  -  **596** (x6)
  -  **588** (x8)
  -  **510** (x10)
  -  **452** (x12)
- NA  
EUR  
ASIA

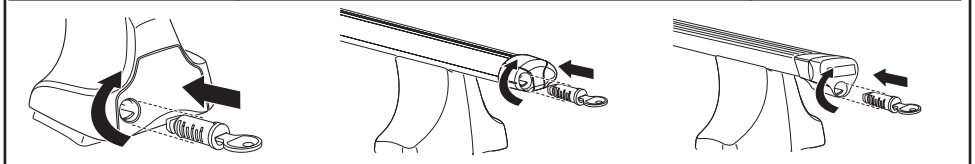

WW ▶ Thule Sweden AB, Box 69, 330 33 Hillerstorp, SWEDEN  
NA ▶ Thule Inc., 42 Silvermine Road, Seymour, Connecticut 06483, USA

info@thule.com  
customer.service@thule.com

 www.thule.com