

Kit 1465

HONDA City, 4-dr Sedan, 09–
HONDA Fit, 5-dr Hatchback, 08–
HONDA Jazz, 5-dr Hatchback, 08–

480R
754

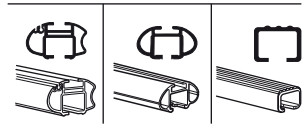
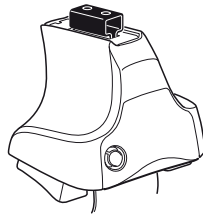

480

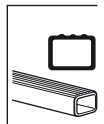
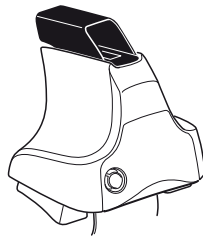

750

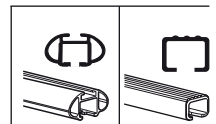
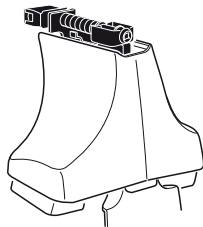

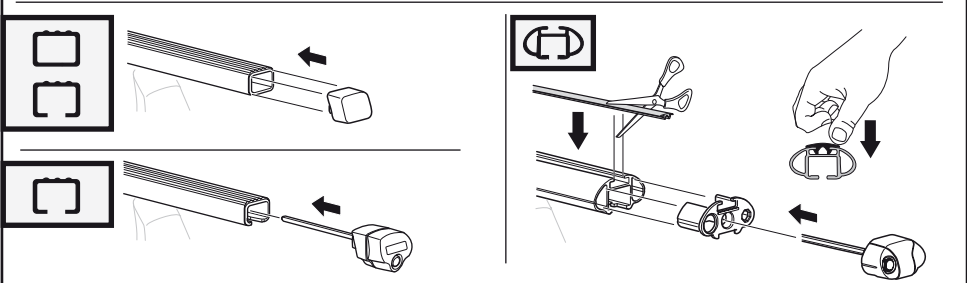
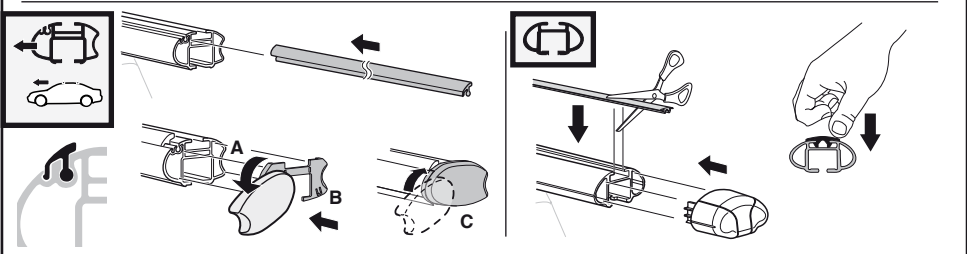
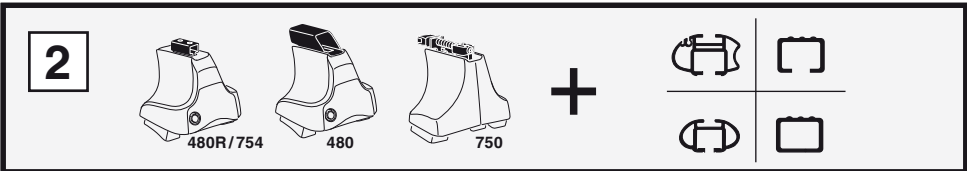
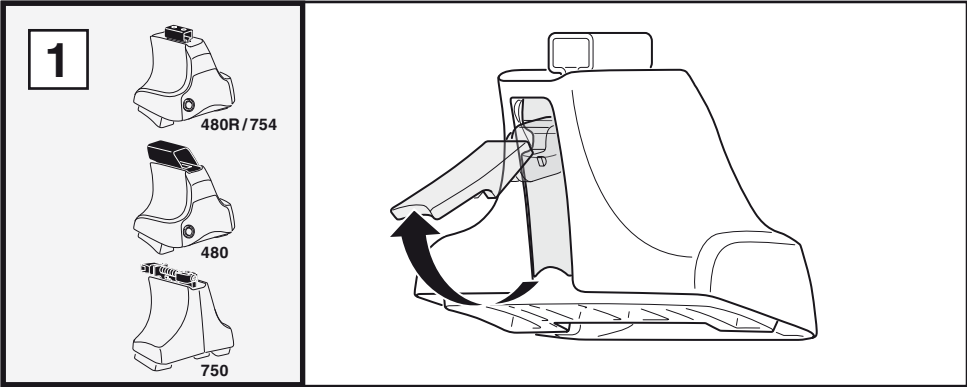

3



754

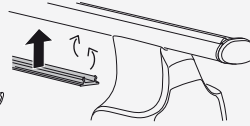
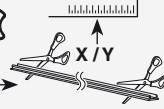

750



1

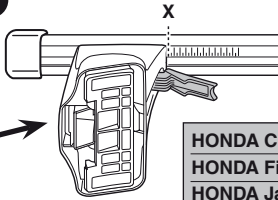
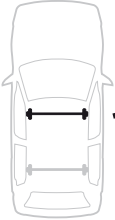

2

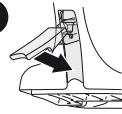

	X
HONDA City, 4-dr Sedan, 09–	33,5
HONDA Fit, 5-dr Hatchback, 08–	30
HONDA Jazz, 5-dr Hatchback, 08–	30

1

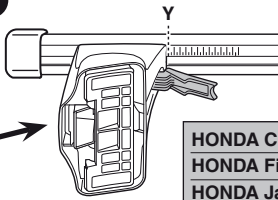

2

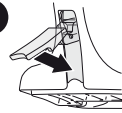

	Y
HONDA City, 4-dr Sedan, 09–	30,5
HONDA Fit, 5-dr Hatchback, 08–	25,5
HONDA Jazz, 5-dr Hatchback, 08–	25,5



480R



480

1

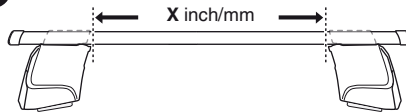

2

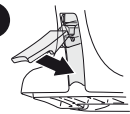

	X inch	X mm
HONDA City, 4-dr Sedan, 09–	38 ⁷ / ₈ "	986 mm
HONDA Fit, 5-dr Hatchback, 08–	37 ¹ / ₄ "	951 mm
HONDA Jazz, 5-dr Hatchback, 08–	37 ¹ / ₄ "	951 mm

1

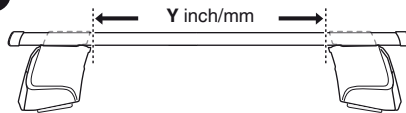

2

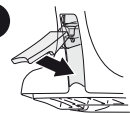

	Y inch	Y mm
HONDA City, 4-dr Sedan, 09–	37 ⁵ / ₈ "	956 mm
HONDA Fit, 5-dr Hatchback, 08–	35 ⁵ / ₈ "	906 mm
HONDA Jazz, 5-dr Hatchback, 08–	35 ⁵ / ₈ "	906 mm

4

HONDA City, 4-dr Sedan, 09–
 HONDA Fit, 5-dr Hatchback, 08–
 HONDA Jazz, 5-dr Hatchback, 08–

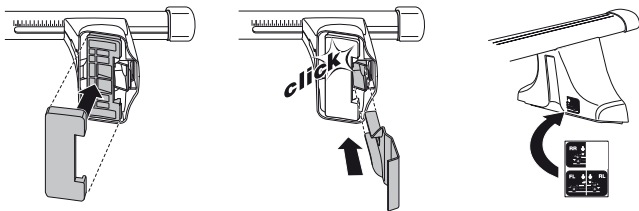
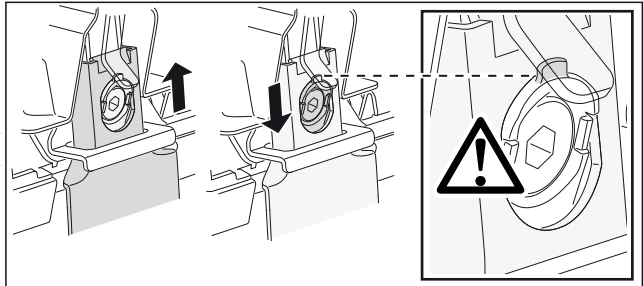
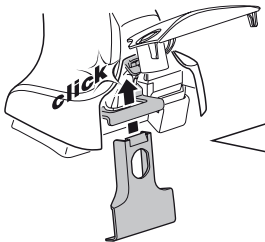
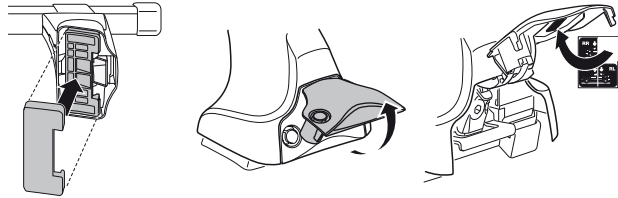
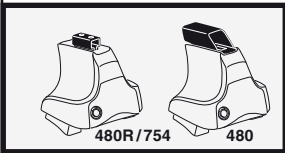
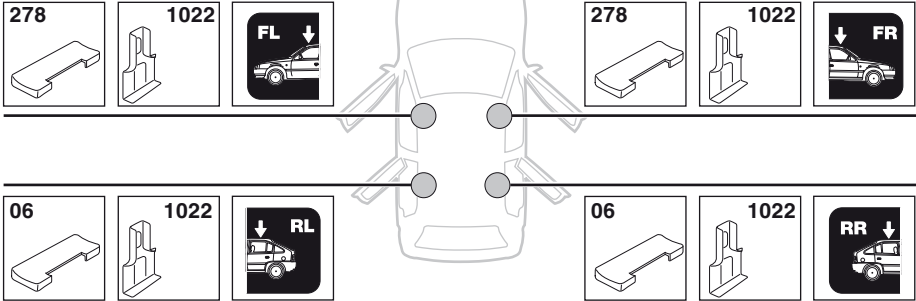

5

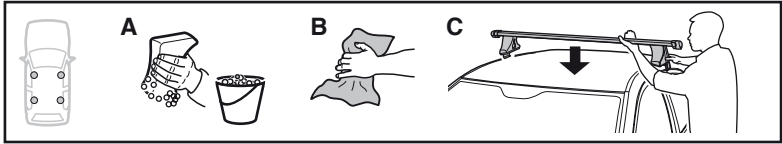

	X mm	Y mm	X inch	Y inch
HONDA City, 4-dr Sedan, 09-	180 mm	700 mm	7 1/8"	27 1/2"
HONDA Fit, 5-dr Hatchback, 08-	310 mm	750 mm	12 1/4"	29 1/4"
HONDA Jazz, 5-dr Hatchback, 08-	310 mm	750 mm	12 1/4"	29 1/4"

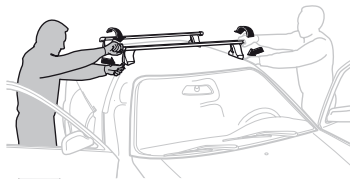
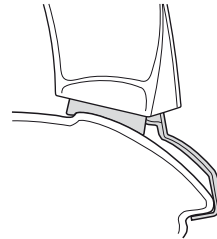
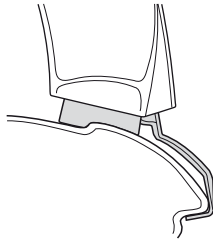
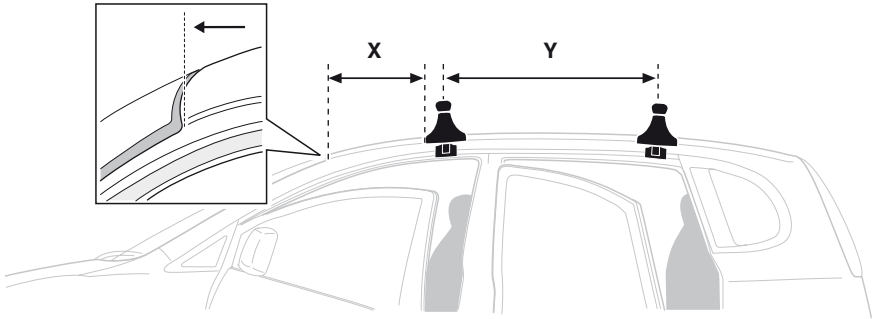

GB/US Tighten alternately

D Die Schrauben abwechselnd anziehen

F Serrer alternativement chaque côté

NL Afwisselend aan de linker- en de rechterkant aandraaien

I Alternare il serraggio delle viti

E Serrare alternativamente

PT Aperte alternadamente

S Dra åt växelvis

FIN Kierrä vuorotellen

EST Pinguldage vaheldumisi

LAT Pielvelciēt pamīšus

LIT Užsukinėkite pakaitomis

PL Śruby dokręcaj naprzemiennie

RU Затягивайте попеременно

CZ Pokręťta bagażníka dokręcaj dokręcaj naprzemiennie.

SK Doťahujte striedavo

SLO Privijajte izmenično.

HR Naizmjenično zategnite

HU Egymástól függetlenül szorítandó

GR Σφίγγετε εναλλάξ

TR Dönüşümlü sıkın

中文 交替拧紧

한국어 번갈아 가며 조이십시오.

日本語 交互に締め付けてください。

ไทย ชั้โน้แบบสลับ

6



480R/754



480

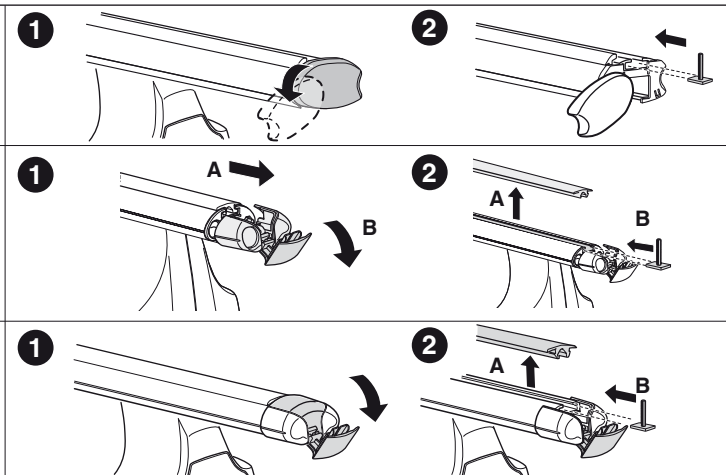
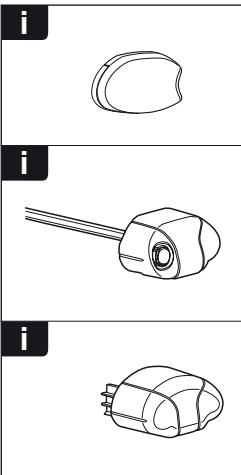
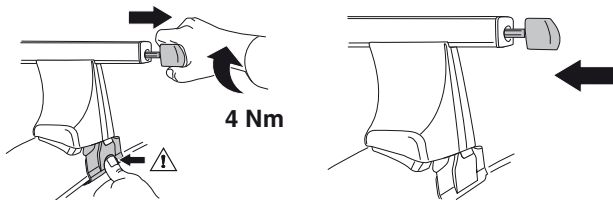
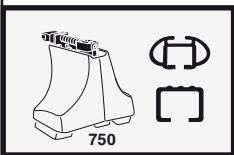
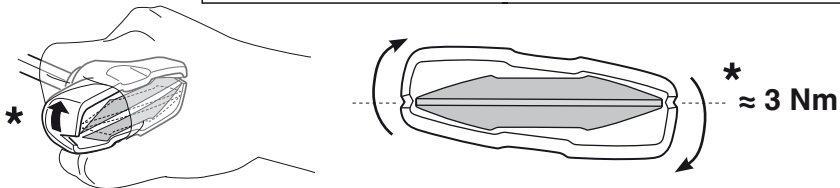
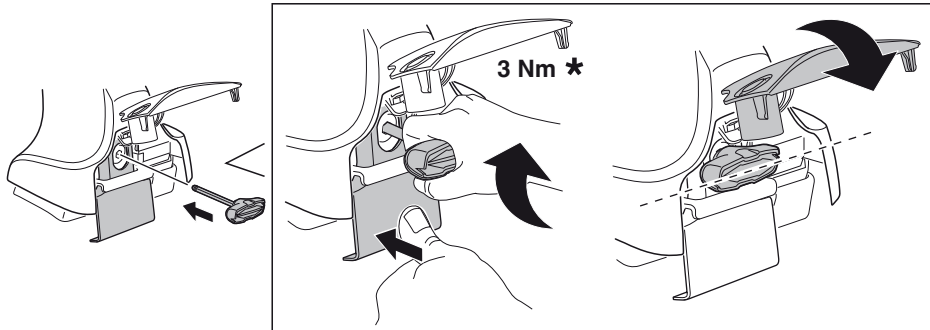

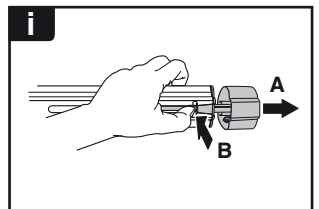
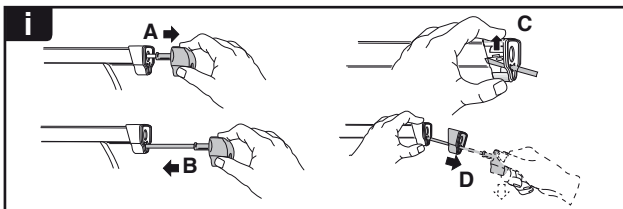
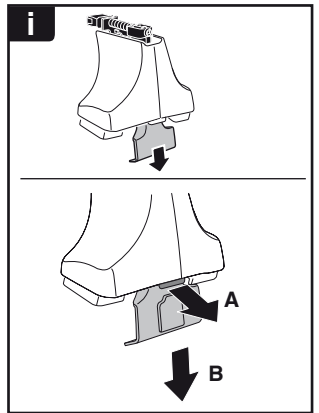
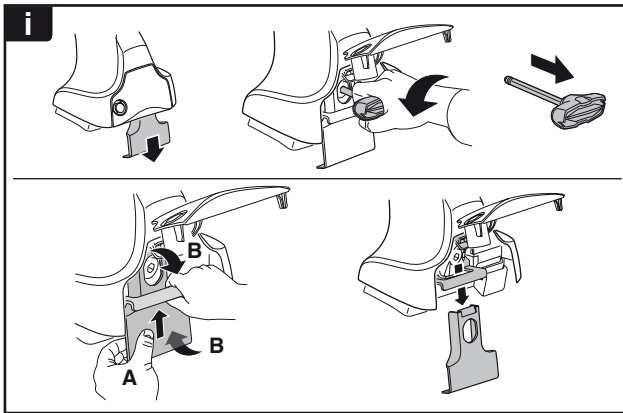
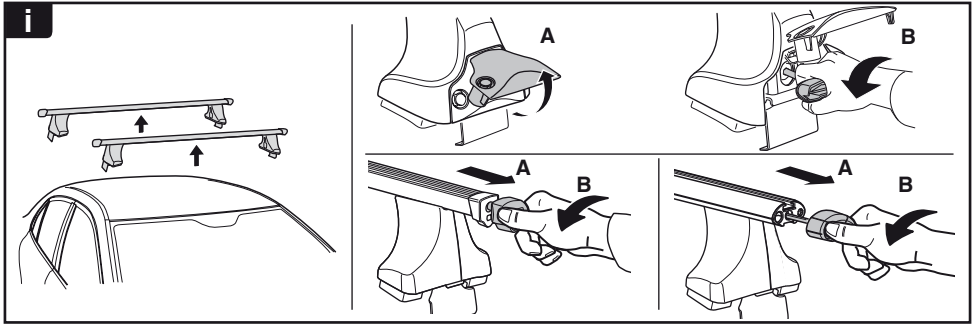

THULE
SWEDEN
**ONE
KEY
SYSTEM**

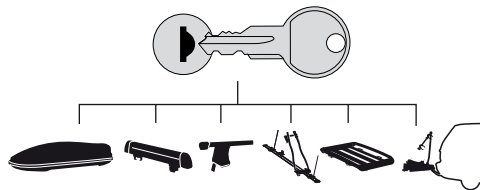

- 544 (x4)
- 596 (x6)
- 588 (x8)
- NA 510 (x10)
- EUR 452 (x12)
- ASIA

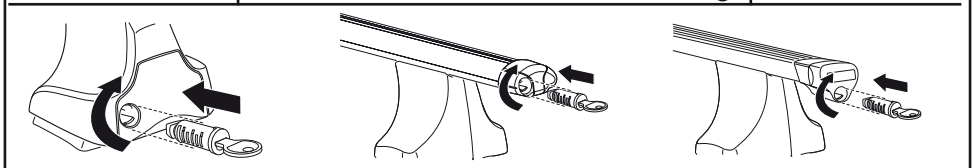

WW ▶ Thule Sweden AB, Box 69, 330 33 Hillerstorp, SWEDEN
NA ▶ Thule Inc., 42 Silvermine Road, Seymour, Connecticut 06483, USA

info@thule.com
customer.service@thule.com

www.thule.com