

Kit 1350

TOYOTA Hilux, 4-dr Double Cab, 05–
TOYOTA Vigo, 4-dr Double Cab, 04–

480R
754

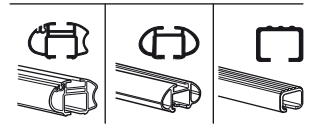
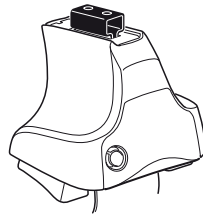

480

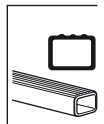
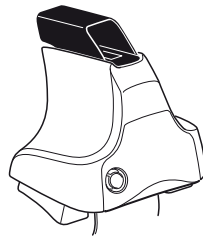

750

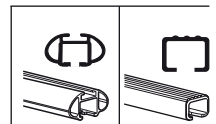
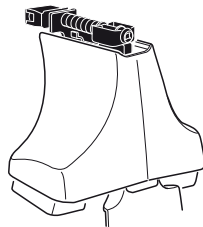

Kit

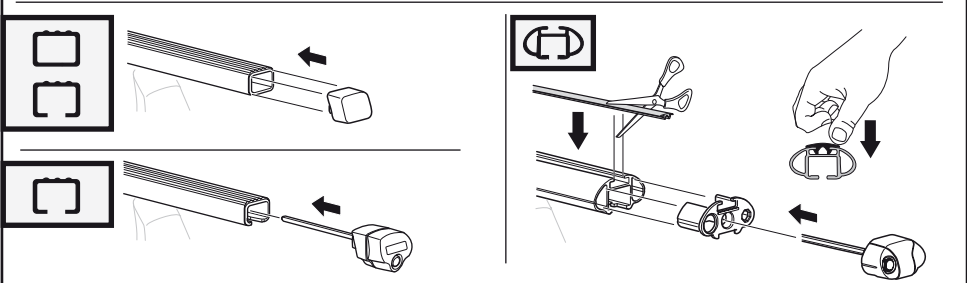
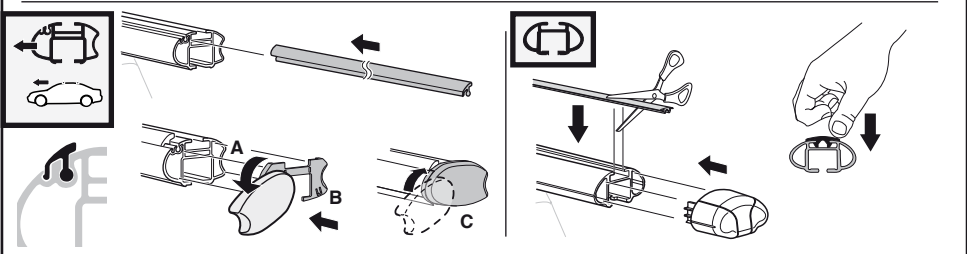
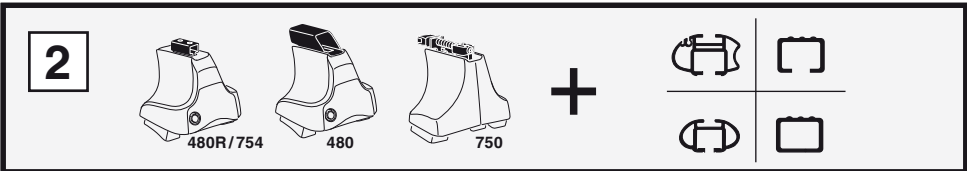
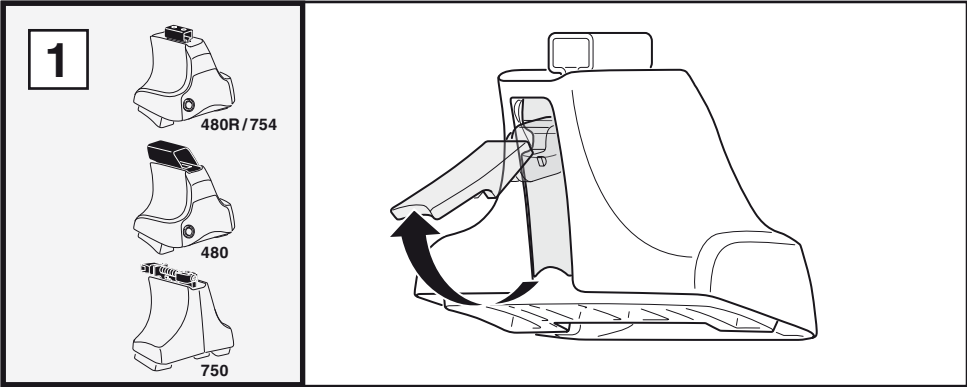

3



754

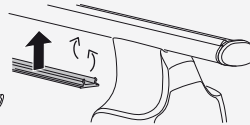
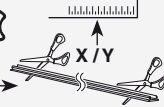

750



1

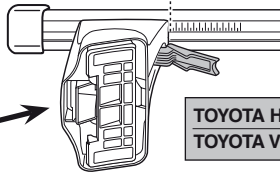
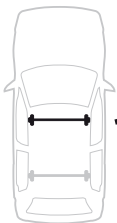

2

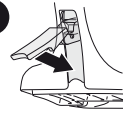

	X
TOYOTA Hilux, 4-dr Double Cab, 05-	41,5
TOYOTA Vigo, 4-dr Double Cab, 04-	41,5

1

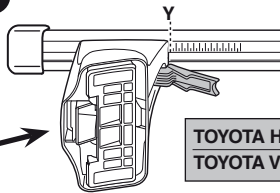

2

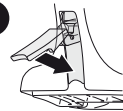

	Y
TOYOTA Hilux, 4-dr Double Cab, 05-	42
TOYOTA Vigo, 4-dr Double Cab, 04-	42



480R



480

1

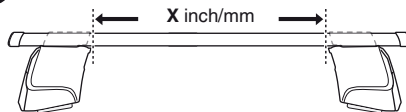

2

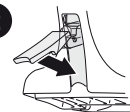

	X inch	X mm
TOYOTA Hilux, 4-dr Double Cab, 05-	42"	1066 mm
TOYOTA Vigo, 4-dr Double Cab, 04-	42"	1066 mm

1

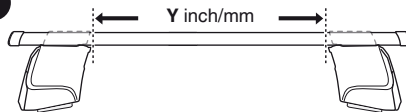

2

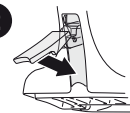

	Y inch	Y mm
TOYOTA Hilux, 4-dr Double Cab, 05-	42 1/8"	1071 mm
TOYOTA Vigo, 4-dr Double Cab, 04-	42 1/8"	1071 mm

4

TOYOTA Hilux, 4-dr Double Cab, 05–
 TOYOTA Vigo, 4-dr Double Cab, 04–

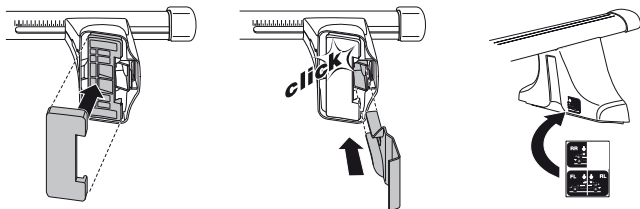
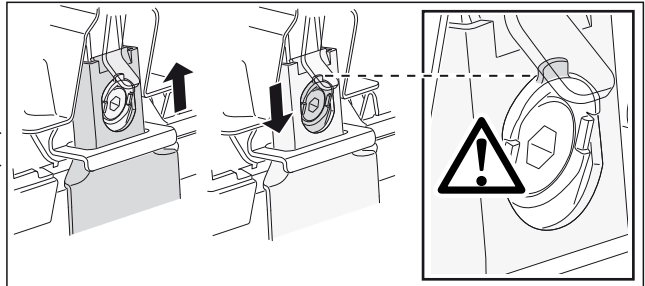
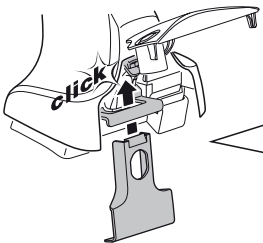
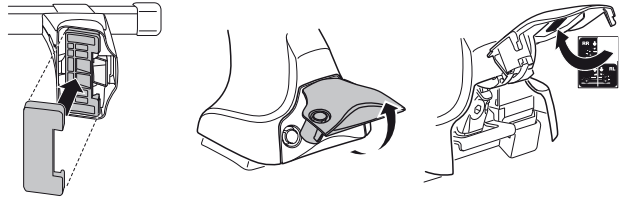
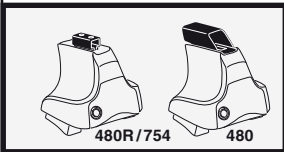
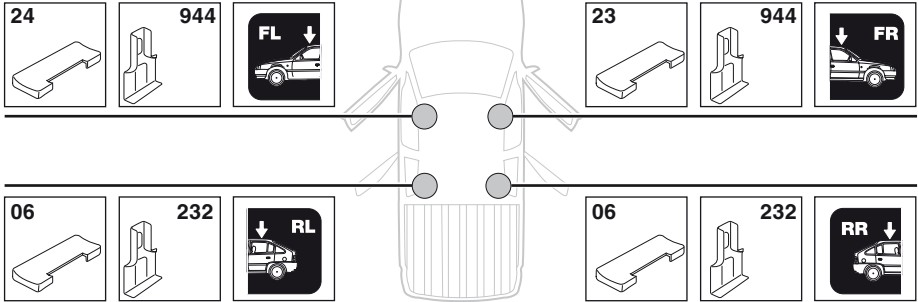

5

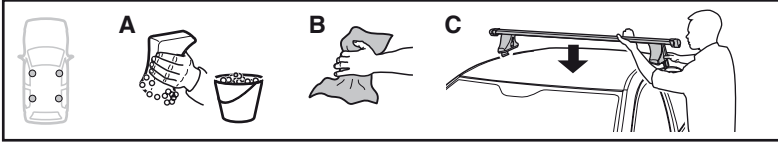

	X mm	Y mm	X inch	Y inch
TOYOTA Hilux, 4-dr Double Cab, 05-	250 mm	720 mm	9 7/8"	28 3/8"
TOYOTA Vigo, 4-dr Double Cab, 04-	250 mm	720 mm	9 7/8"	28 3/8"

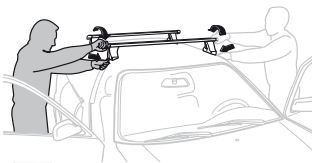
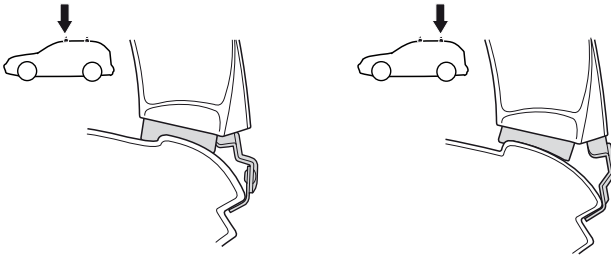
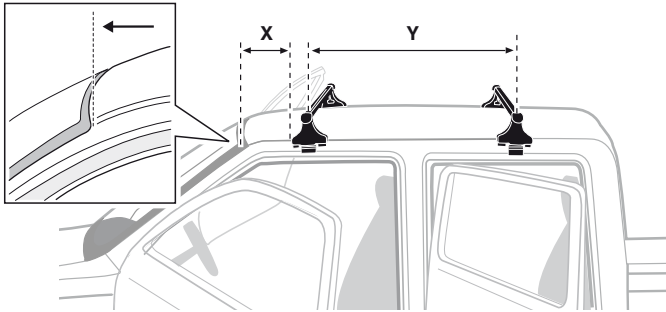

- | | | | |
|--------------|---|------------|---|
| GB/US | Tighten alternately | CZ | Pokreťta bagazníka dokrećaj dokrećaj naprzemiennie. |
| D | Die Schrauben abwechselnd anziehen | SK | Dotahujte striedavo |
| F | Serrer alternativement chaque côté | SLO | Privijajte izmenično. |
| NL | Afwisselend aan de linker- en de rechterkant aandraaien | HR | Naizmjenično zategnite |
| I | Alternare il serraggio delle viti | HU | Egymástól függetlenül szorítandó |
| E | Apretar alternativamente | GR | Σφιγγετε εναλλάξ |
| PT | Aperte alternadamente | TR | Dönüşümlü sıkın |
| S | Dra åt växelvis | 中文 | 交替拧紧 |
| FIN | Kierrä vuorotellen | 한국어 | 번갈아 가며 조이십시오. |
| EST | Pinguldage vaheldumisi | 日本語 | 交互に締め付けてください。 |
| LAT | Pievelciēt pamīšus | ไทย | ขันในแบบสลับ |
| LIT | Užsukinėkite pakaitomis | | |
| PL | Śruby dokrećaj naprzemiennie | | |
| RU | Затягивайте попеременно | | |

6



480R/754



480

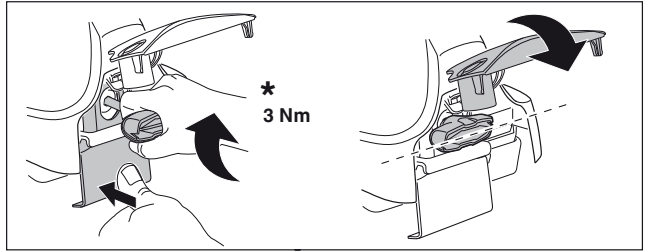
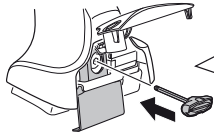

*
3 Nm

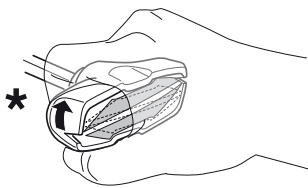

*

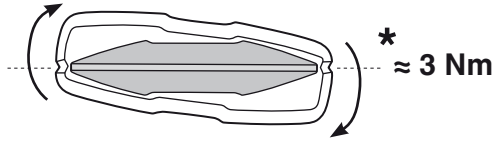

*
≈ 3 Nm

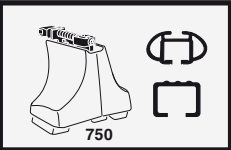
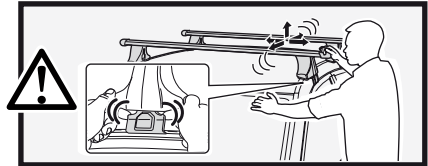

750

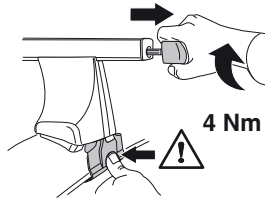

4 Nm

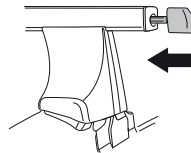

i



1



2

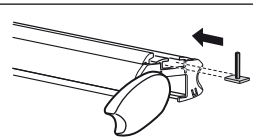

i

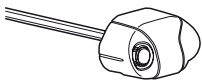

1

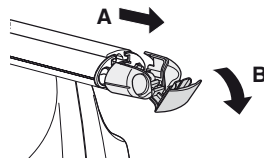

A

B

2

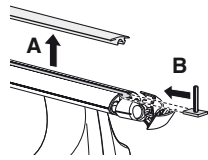

A

B

i



1

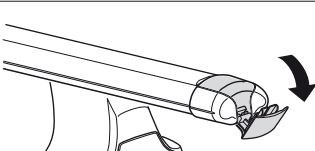

2

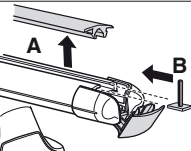

A

B

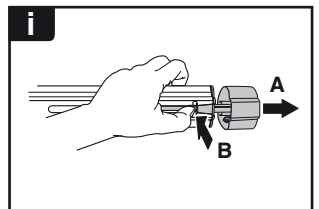
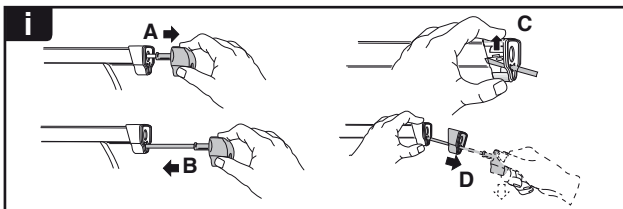
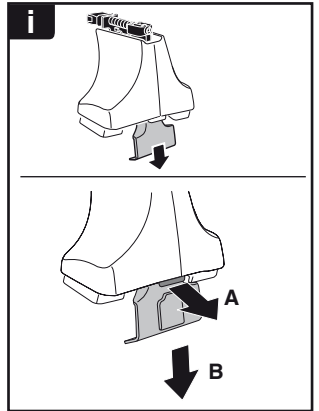
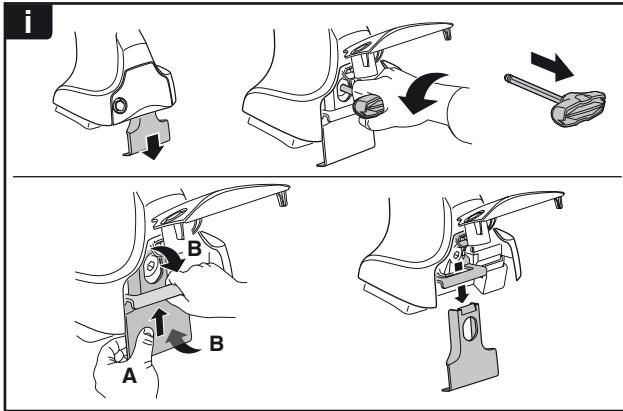
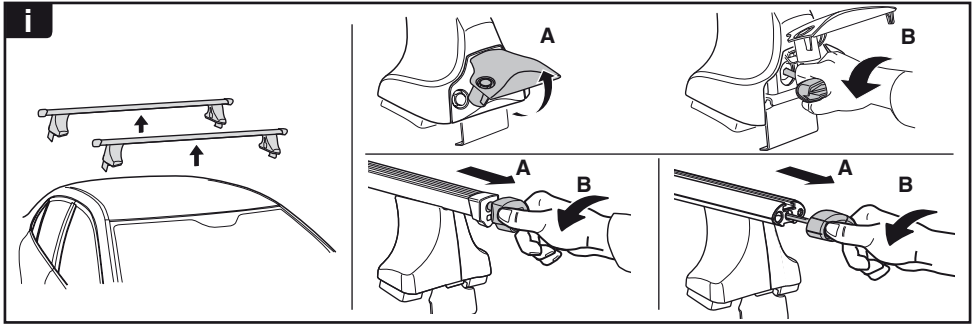

THULE
SWEDEN
**ONE
KEY
SYSTEM**

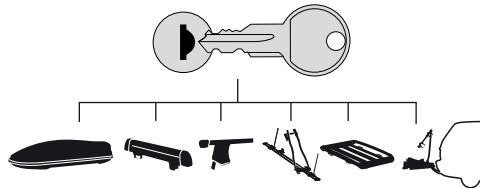

		(x4)
		(x6)
		(x8)
NA		(x10)
EUR		(x12)
ASIA		(x12)

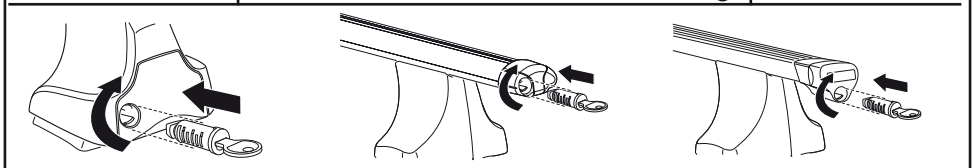

WW ▶ Thule Sweden AB, Box 69, 330 33 Hillerstorp, SWEDEN
NA ▶ Thule Inc., 42 Silvermine Road, Seymour, Connecticut 06483, USA

info@thule.com
customer.service@thule.com

www.thule.com

503-1350-02

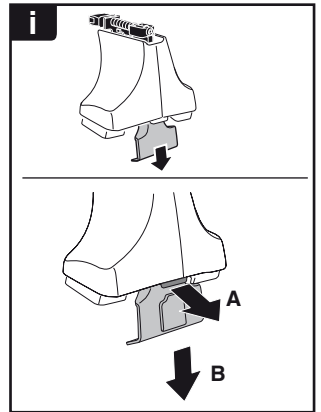
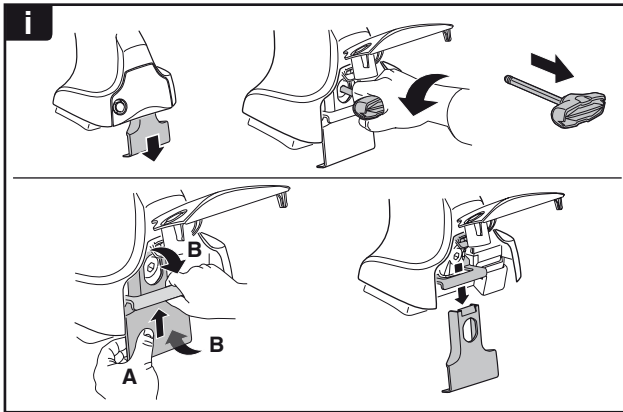
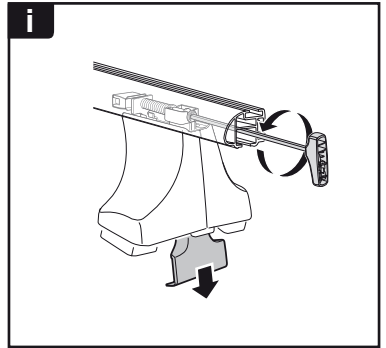
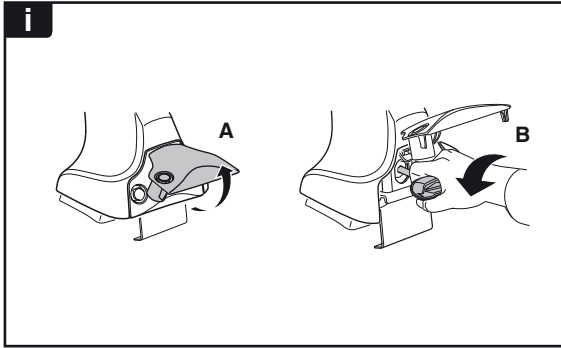
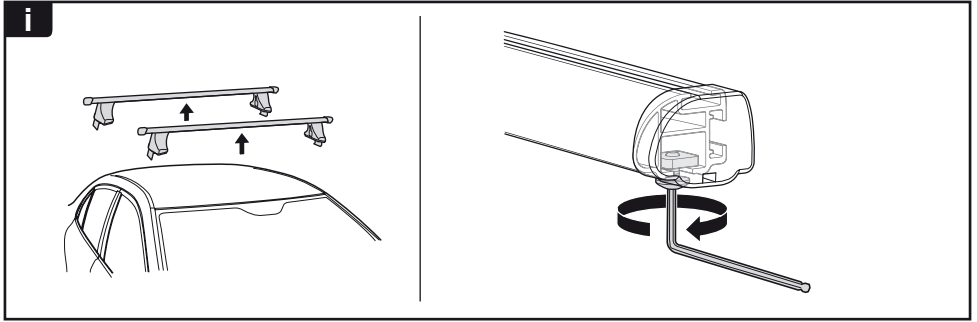

ww ▶ Thule Sweden AB, Box 69, 330 33 Hillerstorp, SWEDEN
 NA ▶ Thule Inc., 42 Silvermine Road, Seymour, Connecticut 06483, USA

@ info@thule.com
 customer.service@thule.com

www.thuleprofessional.com

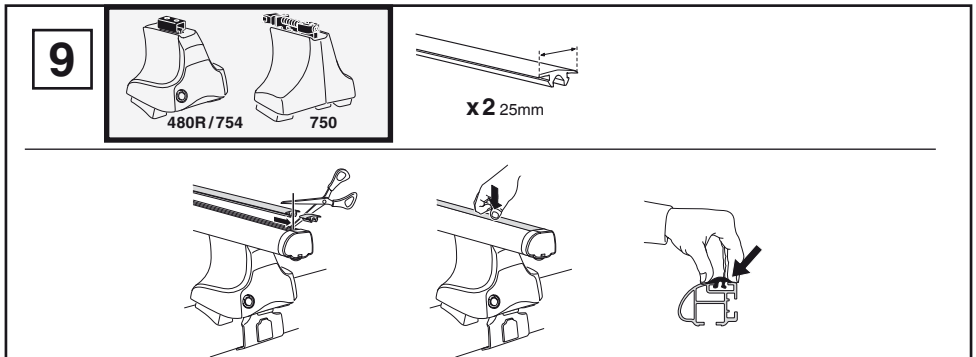
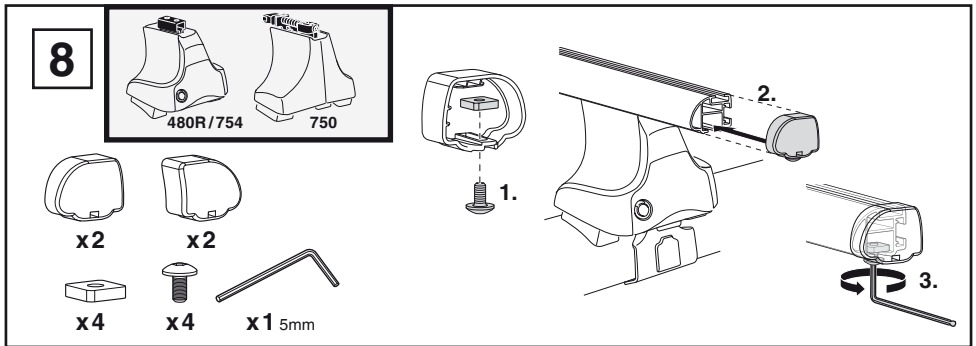
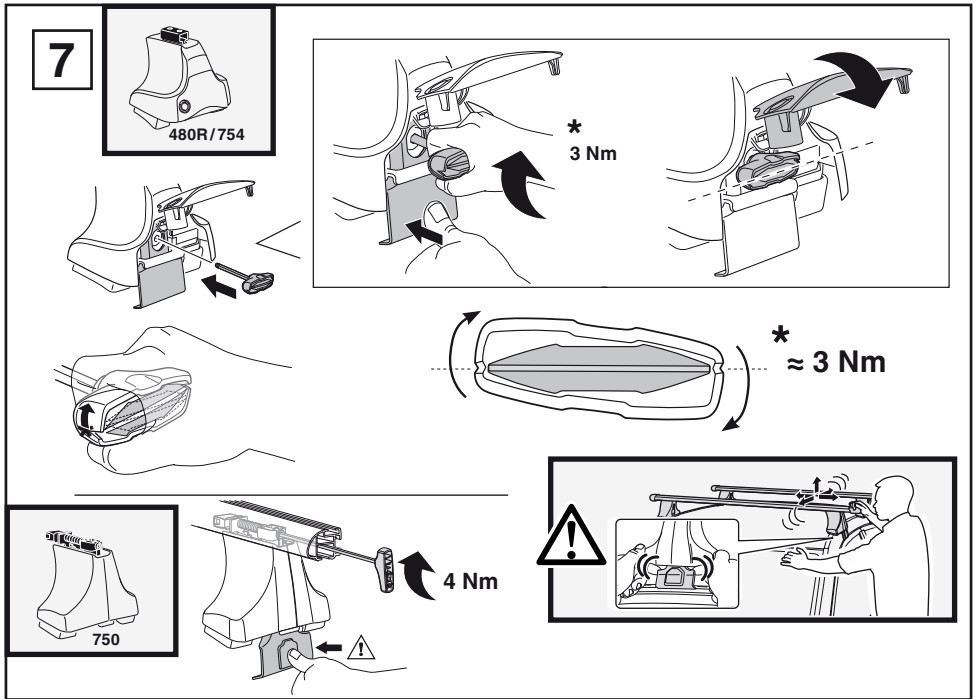

6

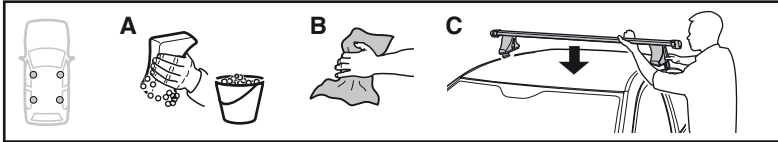

	X mm	Y mm	X inch	Y inch
TOYOTA Hilux, 4-dr Double Cab, 05-	250 mm	720 mm	9 ⁷ / ₈ "	28 ³ / ₈ "
TOYOTA Vigo, 4-dr Double Cab, 04-	250 mm	720 mm	9 ⁷ / ₈ "	28 ³ / ₈ "

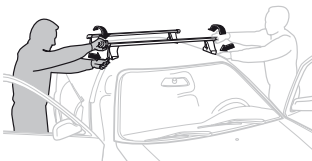
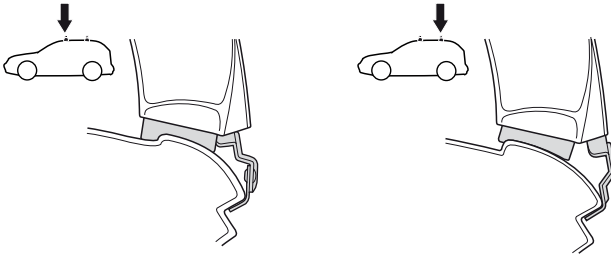
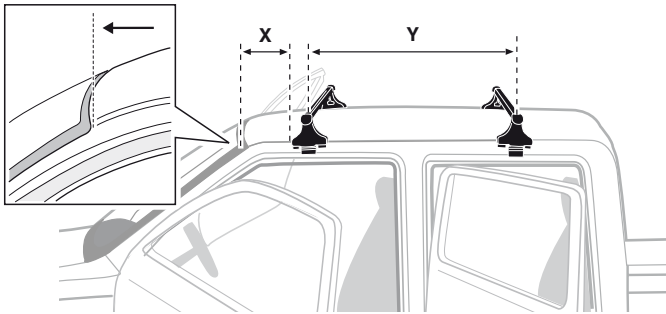

GB/US Tighten alternately
D Die Schrauben abwechselnd anziehen
F Serrer alternativement chaque côté
NL Afwisselend aan de linker- en de rechterkant aandraaien
I Alternare il serraggio delle viti
E Apretar alternativamente
PT Aperte alternadamente
S Dra åt växelvis
FIN Kierrä vuorotellen
EST Pinguldage vaheldumisi
LAT Pievelciēt pamāšus
LIT Užsukinėkite pakaitomis
PL Śruby dokręcaj naprzemiennie
RU Затягивайте попеременно

CZ Pokręťta bagażníka dokręcaj dokręcaj naprzemiennie.
SK Dotahujte striedavo
SLO Privijajte izmenično.
HR Naizmjenično zategnite
HU Egyarástól függetlenül szorítandó
GR Σφιγγετε εναλλάξ
TR Dönüşümlü sıkın

中文 交替拧紧

한국어 번갈아 가며 조이십시오.

日本語 交互に締め付けてください。

ไทย ชั้้นในแบบสลับ

5

TOYOTA Hilux, 4-dr Double Cab, 05–
 TOYOTA Vigo, 4-dr Double Cab, 04–

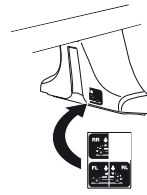
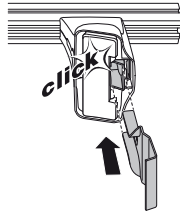
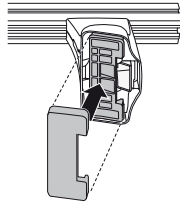
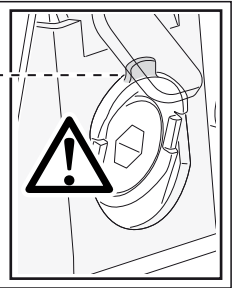
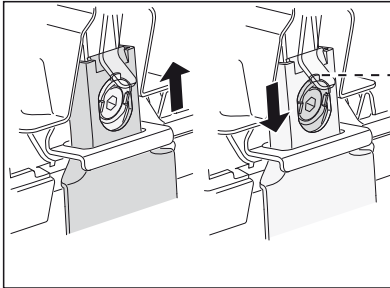
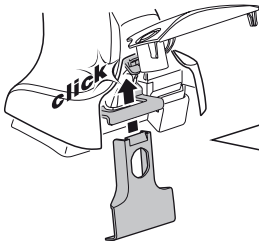
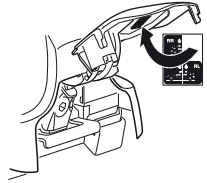
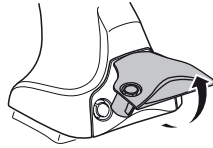
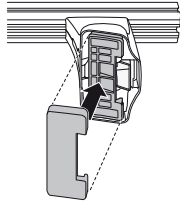
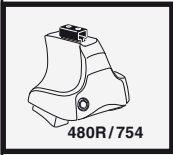
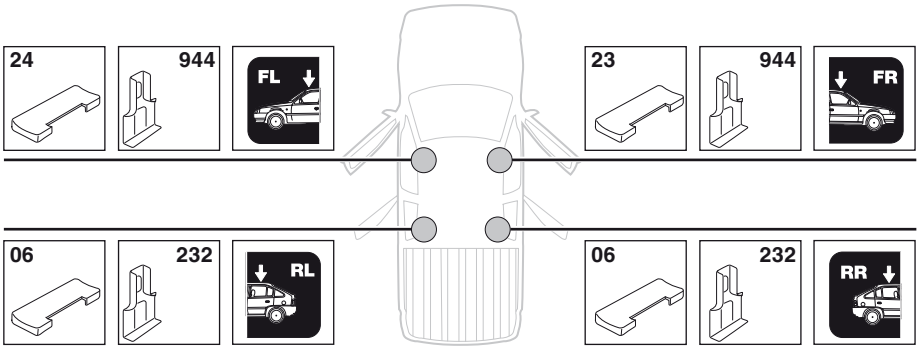

3

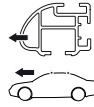
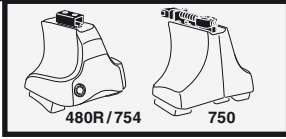

1

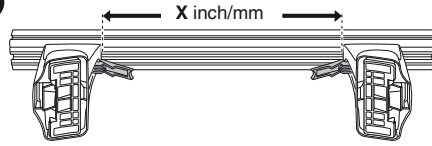

2

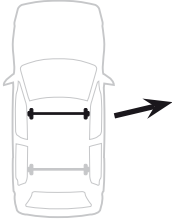

TOYOTA Hilux, 4-dr Double Cab, 05–
TOYOTA Vigo, 4-dr Double Cab, 04–

X inch X mm

42" 1066 mm

42" 1066 mm

1

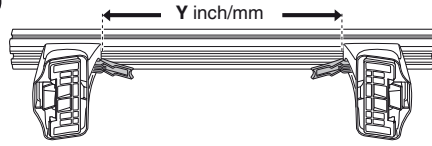

2

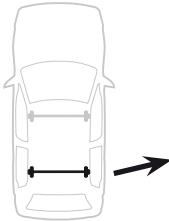
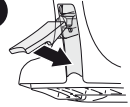

TOYOTA Hilux, 4-dr Double Cab, 05–
TOYOTA Vigo, 4-dr Double Cab, 04–

Y inch Y mm

42 1/8" 1071 mm

42 1/8" 1071 mm

4

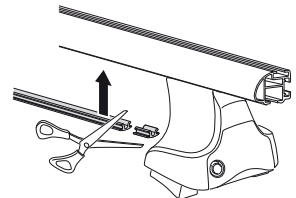
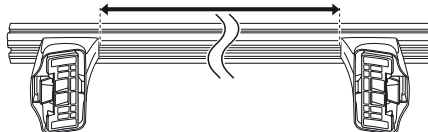
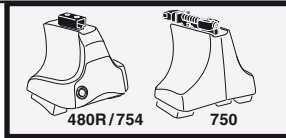

1

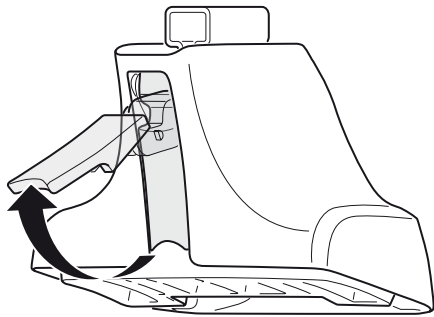
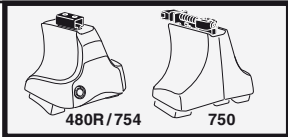

2



+

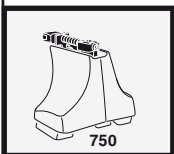
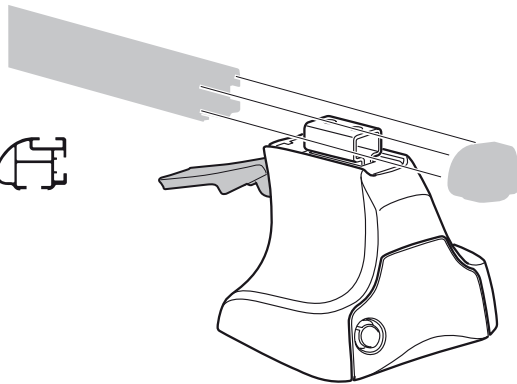

+

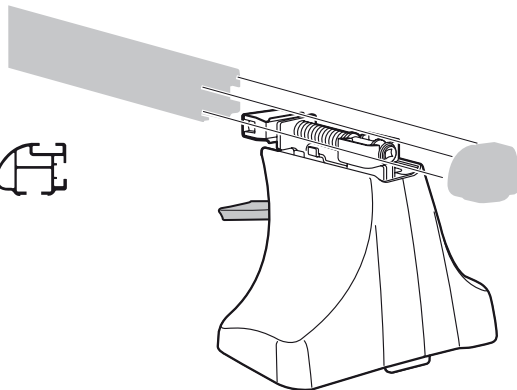

480R/754

750

Kit

instructions

Kit 1350

TOYOTA Hilux, 4-dr Double Cab, 05–
TOYOTA Vigo, 4-dr Double Cab, 04–

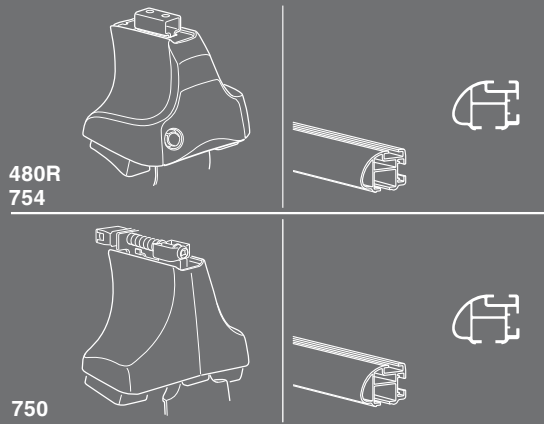

THULE[®]
SWEDEN
PROFESSIONAL

ISO 11154-E